

THULE[®]
SWEDEN

› **All you have to do
is enjoy the ride**

2015



Bring your life
thule.com

Space 08 > 45

What is Thule Space?	08
Awnings	10
Awning Accessories	22
Smart Panels	24
Tents	30
Tent Accessories	44

Storage 46 > 51

What is Thule Storage	46
Flexible Storage	48
Hanging Systems	49
Hard Storage	50

Bike 52 > 71

Why choose a Thule Bike Carrier?	54
Bike Carriers	58
Bike Carrier Accessories	70

Comfort & Security 72 > 81

What is Thule Comfort & Security?	73
Ladders and Roof Rails	74
Steps	76
Ventilation Systems	77
Locks	78
Snow Chains	80
Levelers	81



› Discover all Thule products for your caravan, motorhome or van

Thanks to continuous innovation, we can offer a wider range of products suitable for each type of vehicle. We want to create better possibilities to extend your vehicle with innovative options in different categories. Products that will get the maximum out of your trip and that fit your travel behaviour and specific needs.

Thule Caravan Solutions



Thule Motorhome and Van Solutions



➤ Space





> What is Thule Space?

The private area around your vehicle is important, whether you prefer complete privacy or an open shelter. With a wide range of Thule products, you can enjoy outdoor life while protecting yourself from the sun, rain and wind.



Elected best brand in awnings for years

> Thule Space Solutions



Thule Awnings

Thule offers a wide range of awnings with unique features in order to fit any type of vehicle. Choose the fabric and cassette colour you want!
See p.10



Thule Smart Panels

Awnings can be easily paired with a range of panels to provide extra privacy and protection against sun, rain and wind.
See p.24



Thule Tents

Our tents offer an open feeling of spaciousness while providing enhanced security and privacy. They are modular, stable and solid and are made from high quality materials.
See p.30

Combine the 3 Thule Space Solutions



› Awnings



› Thule awning advantages

The Thule Omnistor awnings have a timeless design, where looks and functionality meet to provide you the ultimate pleasure and comfort. Opening and closing are done in no time thanks to a telescopic handle or a motor kit.



Superior product stability

- Sturdy spring arms in combination with the innovative support of the roller tube create a perfectly tensioned fabric
- Tested in various weather conditions

Wide range of accessories

- Different accessories available to suit your lifestyle
- Awning tents and smart panels
- LED, Thule Hold Down Side Strap Kit, and more...



Ease of use

- Support leg with Quick Release and Quick Lock system
- Manual awnings have a telescopic hand crank
- Motorised awnings have a remote control

Large choice in an appealing design

- Different awning solutions available for different applications
- Colour choice in cassette and fabric finishes

Thule is the preferred awning brand

- Large range of installation brackets designed in cooperation with RV manufacturers
- Elected best brand in awnings for years

› Why choose a wall, roof or rail mounted awning?

Thule offers awnings in 3 different categories to perfectly fit your vehicle and personal needs.



Wall mounted awnings

- Most common installation on the vehicle wall
- Large range of adapters available, developed together with and approved by RV manufacturers
- Easy mounting in the awning rail of a caravan



Roof mounted awnings

- Installed on top of the RV
- Selection of adapters for specific manufacturer's models and most popular vans available
- Better integrated on the current RV design
- Alternative in case of lack of space or width restrictions



Rail mounted awnings

- Easy installation, no brackets needed: fits into the caravan rail
- Not permanent: you can still switch between awning and canopy

> Thule finishes

Cassette finishes

All Thule Omnistor awnings are made from sturdy, stable aluminium profiles that guarantee long-lasting safety and reliability.



Anodised

White



Anthracite

Cream

Fabric finishes

Depending on the type of awning, you can choose different patterns for your awning fabric.

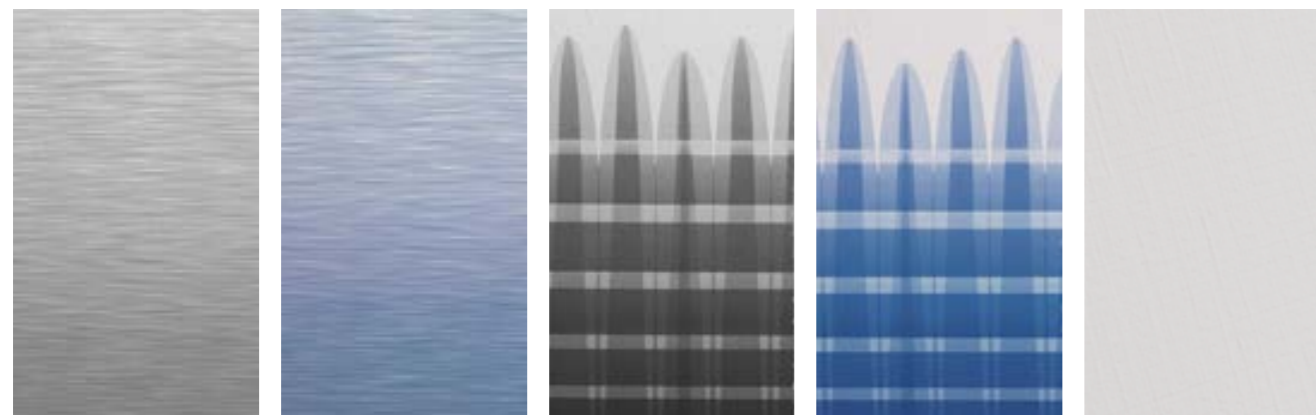

31 - Mystic grey

32 - Sapphire blue

04 - Alaska grey

03 - Blue sky

22 - Uni grey

SPECIFICATIONS



The coating not only ensures a high degree of scratch and fade-resistance, but also increases UV and heat-resistance.



For extreme long-lasting reliability
Top-quality PVC fabric is composed of 5 layers to ensure that the awning is watertight, washable, durable and resistant to scratches.

1. PVC top coat: ensures colour protection and scratch resistance
2. Vinyl with printed pattern
3. Strong layer in polyester scrim

Select your awning and favourite cassette and fabric finish - To find out the available colours for each fabric, please refer to each awning

> Whatever your vehicle, find the Thule Omnistor awning you need!

		Length	Projection	Weight	Motor	Cassettes	Tents
You have a Motorhome	Wall mounting						
	Thule Omnistor 8000	p.14	3.50 > 6.00m	2.50 > 2.75m	38 > 55.40kg	• 220V	4 - See p.30
	Thule Omnistor 5003	p.15	1.90 > 4.50m	1.40 > 2.50m	15 > 33.20kg		4 - See p.30
	Thule Omnistor 4900	p.16	2.60 > 4.50m	2.00 > 2.50m	17.50 > 27.80kg		3 - See p.30
	Roof mounting						
	Thule Omnistor 9200	p.20	4.00 > 6.00m	3.00m	42.40 > 57.60kg	• 220V	4 - See p.30
	Thule Omnistor 6200	p.21	2.60 > 4.50m	2.00 > 2.50m	19.60 > 31.40kg		4 - See p.30

		Length	Projection	Weight	Motor	Cassettes	Tents
You have a Caravan	Wall mounting						
	Thule Omnistor 8000	p.14	3.50 > 6.00m	2.50 > 2.75m	38 > 55.40kg	• 220V	4 - See p.30
	Thule Omnistor 5003	p.15	1.90 > 4.50m	1.40 > 2.50m	15 > 33.20kg		4 - See p.30
	Thule Omnistor 4900	p.16	2.60 > 4.50m	2.00 > 2.50m	17.50 > 27.80kg		3 - See p.30
	Thule Omnistor 2000	p.17	1.90 > 3.00m	1.30 > 2.15m	11 > 17.50kg		
	Roof mounting						
	Thule Omnistor 9200	p.20	4.00 > 6.00m	3.00m	42.40 > 57.60kg	• 220V	4 - See p.30
	Thule Omnistor 6200	p.21	2.60 > 4.50m	2.00 > 2.50m	19.60 > 31.40kg		4 - See p.30
	Rail mounting						
New	Thule Omnistor 1200	p.18	2.30 > 4.50m	2.00 > 2.50m	9 > 16.60kg	White bag	1 - See p.30

		Length	Projection	Weight	Motor	Cassettes	Tents
You have a Van	Wall mounting						
	Thule Omnistor 5003	p.15	1.90 > 4.50m	1.40 > 2.50m	15 > 33.20kg		4 - See p.30
	Thule Omnistor 4900	p.16	2.60 > 4.50m	2.00 > 2.50m	17.50 > 27.80kg		3 - See p.30
	Thule Omnistor 5102*	p.17	2.60m	2.00m	19.80kg		1 - See p.30
	Thule Omnistor 2000	p.17	1.90 > 3.00m	1.30 > 2.15m	11 > 17.50kg		
	Roof mounting						
	Thule Omnistor 6200	p.21	2.60 > 4.50m	2.00 > 2.50m	19.60 > 31.40kg		4 - See p.30

* Suitable for VW T5

Thule Omnistor 8000

Leader in technology

🇨🇭 Largest wall awning on the market, up to: **6x2.75m**

WALL MOUNTING

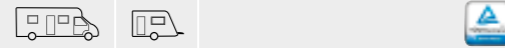

Perfect tension. Thanks to Thule's unique integrated tension rafter in the spring arm, the fabric is always well tensioned. The spring arm, reinforced with a double steel cable, automatically deploys the tension rafter to ensure the awning stays stable and resistant to wind.

Easy cleaning. As standard, the Thule Omnistor 8000 is equipped with its own drainage system. This is convenient in case of rain but also when cleaning the fabric once or twice a year with the Thule PVC Cleaner.

Easy and safe. The optional 220 VAC motor with remote control allows you to open the awning without any effort. Settings are programmed digitally so that the awning always closes correctly. A safety device has been created to operate the awning in case of electricity failure.

CASSETTE FINISHES



FABRIC FINISHES

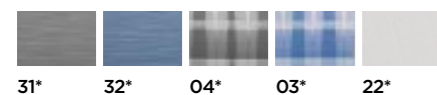

FITS

Tents: Thule Panorama p.36 - Thule Residence G2 p.38 - Thule QuickFit p.40 - Thule EasyLink p.42
Smart Panels: Thule Blockers G2 p.26 - Thule Windscreen p.29

ACCESSORIES

Thule LED - Thule Hold Down Side Strap Kit - Thule Tension Rafter - and more - p.22
Motor: a retrofit motor can be installed after purchase (+2kg)

MODELS

Length	Projection	Weight
3.50m	2.50m	38.00kg
4.00m	2.75m	41.40kg
4.50m	2.75m	44.60kg
5.00m	2.75m	48.20kg
5.50m	2.75m	51.80kg
6.00m	2.75m	55.40kg

* For fabric availability please contact your Thule recreational vehicle advisor

Thule Omnistor 5003

Forever classic

🇨🇭 Extensive range of sizes: **1.90 to 4.50m length**

WALL MOUNTING



Perfect design. The Thule Omnistor 5003 has been designed to perfectly fit your vehicle. Its curves and straight lines combine to form a perfect harmony.

Easy cleaning. As standard, the Thule Omnistor 5003 is equipped with its own drainage system. This is convenient in case of rain but also when cleaning the fabric once or twice a year with the Thule PVC cleaner.

Extra safety. The unique Thule double lock system ensures automatic locking of the front profile and cassette while the awning is closed. This added safety device completely prevents the awning from opening while the vehicle is moving.

CASSETTE FINISHES



FABRIC FINISHES



FITS

Tents: Thule Panorama p.36 - Thule Residence G2 p.38 - Thule QuickFit p.40 - Thule EasyLink p.42
Smart Panels: Thule Blockers G2 p.26 - Thule Windscreen p.29

ACCESSORIES

Thule LED - Thule Hold Down Side Strap Kit - Thule Tension Rafter - and more - p.22

MODELS

Length	Projection	Weight
1.90m	1.40m	15.00kg
2.30m	1.80m	18.00kg
2.60m	2.00m	20.00kg
3.00m	2.50m	23.00kg
3.50m	2.50m	26.00kg
4.00m	2.50m	30.20kg
4.50m	2.50m	33.20kg

* For fabric availability please contact your Thule recreational vehicle advisor

Thule Omnistor 4900

The leader in lightweight

+ **Lightweight: 17.5kg**
for 2.60m length with
a projection of 2m

WALL MOUNTING

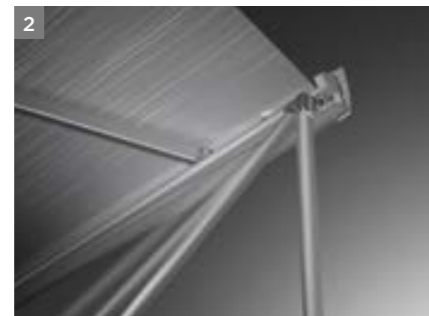

Lightness and stability. Our engineers have invented an awning equipped with a small roller tube which enables a huge weight reduction, while increasing stability and optimising fabric tension.

Smart innovations. New design: the oval support legs are dropped vertically to reduce the risk of damaging your vehicle.

Optimal closing. The unique new Thule cassette adjustment system means perfect closing of the awning even after years of usage.

CASSETTE FINISHES



FABRIC FINISHES

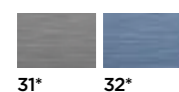

FITS

Tents: Thule Residence G2 p.38 - Thule QuickFit p.40 - Thule EasyLink p.42
Smart Panels: Thule Blockers G2 p.26 - Thule Windscreen p.29

ACCESSORIES

Thule LED - Thule Hold Down Side Strap Kit - Thule Tension Rafter - and more - p.22

MODELS

Length	Projection	Weight
2.60m	2.00m	17.50kg
3.00m	2.50m	19.60kg
3.50m	2.50m	21.60kg
4.00m	2.50m	25.60kg
4.50m	2.50m	27.80kg

* For fabric availability please contact your Thule recreational vehicle advisor

Thule Omnistor 5102

Conceived for VW T5

+ Perfect fit for
VW T5: **2.60x2m**

WALL MOUNTING

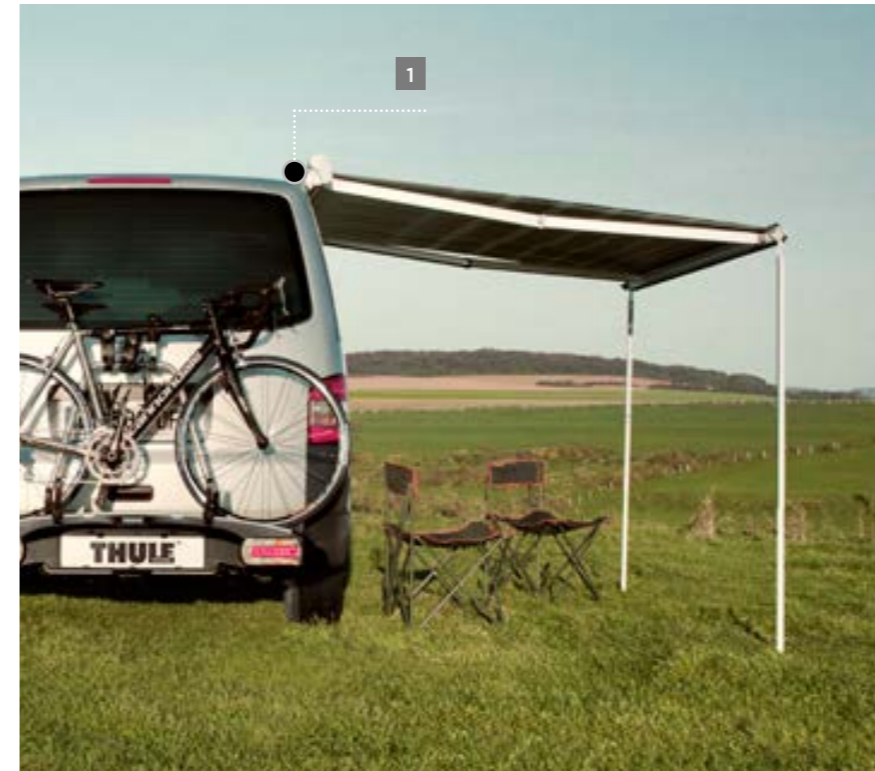
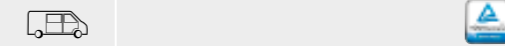

Easy installation. The Thule Omnistor 5102 is developed together with and approved by VW. Its easy installation makes it the perfect fit for city living. For T5 with rack rails. **Ask your VW dealer for more information.**

CASSETTE FINISHES

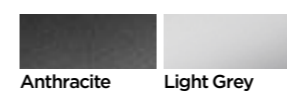

FABRIC FINISH



FITS

Tents: Thule Residence G2 / special VW T5 p.38
Smart Panels: Thule Blockers G2 p.26 - Thule Windscreen p.29

ACCESSORIES

Thule LED - Thule Hold Down Kit - and more - p.22

MODELS

Length	Projection	Weight
2.60m	2.00m	19.80kg

Thule Omnistor 2000

For small vehicles

+ Small length and
projection: **1.90x1.30m**

WALL MOUNTING



CASSETTE FINISH



FABRIC FINISHES

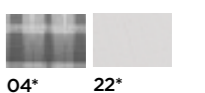

FITS

Smart Panels: Thule Blockers G2 p.26 - Thule Windscreen p.29

MODELS

Length	Projection	Weight
1.90m	1.30m	11.00kg
2.60m	2.00m	14.50kg
3.00m	2.15m	17.50kg

Extra safety. A manual lock system and security lock prevent the awning from opening while your vehicle is moving. The automatic roll-in system makes it easy and quick to pack. This awning perfectly fits caravans, small vehicles, SUV and is very light.

New

Thule Omnistor 1200

Stability and large projection, all fitting in a small bag

CARAVAN RAIL MOUNTING



+ Largest projection for a bag awning: **2.50m**

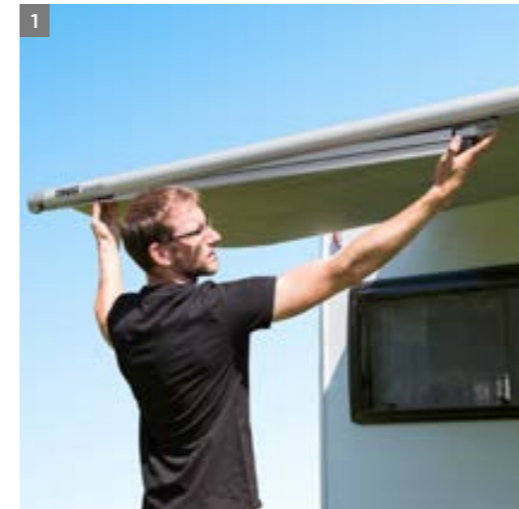

Easy and fast set-up of the awning. The simultaneous swing-out of the support and tension legs enables an easy and fast set-up.



Exclusive fabric tensioning system with pump-buckle technology. Extremely user-friendly: click back and forwards to ensure the awning fabric is perfectly tensioned.



Perfect stability. Remarkable stability for a bag awning thanks to the sturdy roller tube with integrated support and tension legs. Awnings longer than 4.00m have an integrated fixation for an optional 3rd support leg which ensures a higher stability.

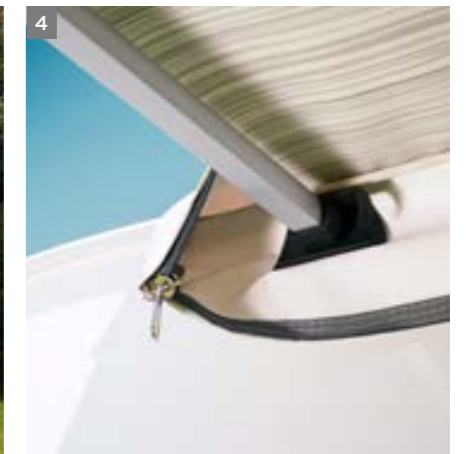

Support kit. A clever integrated tension leg support kit spreads the load safely on the caravan wall. This all fits into a small white bag.



BAG FINISH



White

FABRIC FINISHES



31*

32*

FITS

Tents: Thule QuickFit p.40 - Thule EasyLink p.42
Smart Panels: Thule Blockers G2 p.26 - Thule Windscreen p.29

ACCESSORIES

Thule Hold Down Side Strap Kit - Thule Tension Rafter - and more - p.22

MODELS

Length	Projection	Weight
2.30m	2.00m	9.00kg
2.60m	2.20m	10.40kg
3.00m	2.50m	12.00kg
3.25m	2.50m	12.60kg
3.50m	2.50m	13.40kg
3.75m	2.50m	14.20kg
4.00m	2.50m	15.00kg
4.25m	2.50m	15.80kg
4.50m	2.50m	16.60kg

* For fabric availability please contact your Thule recreational vehicle advisor

Thule Omnistor 9200

For extra large vehicles

+

The biggest projection:
3 meters

ROOF MOUNTING



Perfect tension. Sturdy spring arms ensure the awning fabric is perfectly tensioned. They also increase resistance to wind for safer usage. The spring arm, reinforced with a double steel cable, automatically deploys the tension rafter to ensure the awning stays stable and resistant to wind.

Perfect Design. The Thule Omnistor 9200 has been designed to perfectly integrate with any vehicle design. It is especially convenient for large vehicles.

Easy and safe. The optional 220 VAC motor with remote control allows you to open the awning without any effort. Settings are programmed digitally so that the frame always closes correctly. A safety device has been created to operate the awning in case of electricity failure.

CASSETTE FINISHES



FABRIC FINISHES

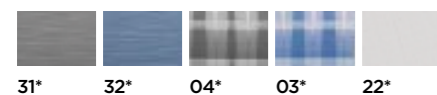

FITS

Tents: Thule Panorama p.36 - Thule Residence G2 p.38 - Thule QuickFit p.40 - Thule EasyLink p.42
Smart Panels: Thule Blockers G2 p.26 - Thule Windscreen p.29

ACCESSORIES

Thule LED - Thule Hold Down Side Strap Kit - Thule Tension Rafter - and more - p.22
Motor: a retrofit motor can be installed after purchase (+2kg)

MODELS

Length	Projection	Weight
4.00m	3.00m	42.40kg
4.50m	3.00m	45.60kg
5.00m	3.00m	50.20kg
5.50m	3.00m	53.60kg
6.00m	3.00m	57.60kg

* For fabric availability please contact your Thule recreational vehicle advisor

Thule Omnistor 6200

Universal roof awning

+

Extensive range of sizes:
2.60 to 4.50m

ROOF MOUNTING



Maximum flexibility. The Thule Omnistor 6200 has been conceived with a range of adapters to fit all types of recreational vehicles, especially vans. In sizes from 2.60 to 4.50 meters, it suits most vehicles on the market.

Less weight. In its aim to fulfill market's needs, Thule launches lighter awnings. The Thule Omnistor 6200 is up to 20% lighter than its predecessor. Thanks to the adjustable pitch system, the awning can be opened and closed even when the sliding door of your van is open.

Clever ideas. Our engineers have created space for the Thule LED lighting, so that your vehicle can have light on the outside even when your awning is closed.

CASSETTE FINISHES



FABRIC FINISHES

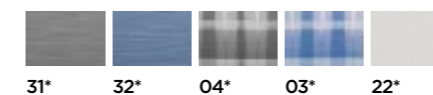

FITS

Tents: Thule Panorama p.36 - Thule Residence G2 p.38 - Thule QuickFit p.40 - Thule EasyLink p.42
Smart Panels: Thule Blockers G2 p.26 - Thule Windscreen p.29

ACCESSORIES

Thule LED - Thule Hold Down Side Strap Kit - Thule Tension Rafter - and more - p.22

MODELS

Length	Projection	Weight
2.60m	2.00m	19.60kg
3.00m	2.50m	23.00kg
3.25m	2.50m	24.00kg
3.50m	2.50m	25.40kg
3.75m	2.50m	27.00kg
4.00m	2.50m	29.00kg
4.25m	2.50m	30.20kg
4.50m	2.50m	31.40kg

* For fabric availability please contact your Thule recreational vehicle advisor

Thule Awning Accessories

It's all in the details

+ Complete your awning to your needs



Thule LED - Light system

This long-lasting LED strip offers strong lighting (60 power LEDs per meter) and is waterproof (IP66). The unit, flexible in length can be shortened each 5cm. Delivered with a 3M tape on the back, it sticks to most standard surfaces.

- Available in various lengths from 1 to 6m • Voltage: 12V DC • Consumption: 340-380 mA per metre



Thule Hold Down Side Strap Kit

This kit prevents the awning and tent from being damaged due to high wind. The kit is attached to the support legs and can easily be used in combination with a Thule tent or Thule Smart Panels.

- 307916



Thule Hold Down Kit

This kit strengthens your awning and tent to prevent them from flying up. It is installed over the awning length between the spring arms and the fabric.

- 307906



Thule PVC Cleaner

A long lasting awning is an awning that is well kept. Use the Thule PVC Cleaner ones or twice a year to maintain your awning fabric. Protects by applying a water-repellent and anti-static film.

- 307585



Rafter system option



Thule Universal Rafter - straight

Secure your awning even in high wind, thanks to this straight aluminium tension arm with telescopic operation.

- For awnings with a projection up to 3.00m

Thule Universal Rafter - bended

This curved aluminium tension will help you feel safe and secure, while also improving rainwater drainage.

- For awnings with a projection up to 3.00m and a length of 3.50m or more

Thule Supplementary Rafter

Straight painted steel tension arm with a compression spring. For awnings from 3.50m or more in length. Includes installation pieces. Ideal for improving rainwater drainage.

- Different models available from 2.00m to 2.75m



Thule EPDM

This black EPDM foam strip with closed cell structure seals the gap between the vehicle and awning. Perfect for roof mounted awnings.

- Length: 2 x 2m
- Thickness: 25mm
- Width: 30mm
- 308697



Thule Sealing Rubber

Ensures that the gap between the vehicle and awning is sealed when using a flat adapter. Fitted with an integrated drainage system. Perfect for wall mounted awnings.

- For series 5 and 8:
- Small 5cm / 4m - 307960
- Large 8cm / 4m - 307961
- Only for 4900:
- Medium 6cm / 4m - 306892



Thule Gutter

This self-adhesive drainage system fits most caravans and motorhomes.

- Available in 2 sizes:
- 3.50m: 307947
- 4.50m: 307967

See more information on www.thule.com

› Smart Panels



› What are Smart Panels ?

To create your own privacy under your awning, Thule offers different panels to protect you against sun, rain and wind. These panels can be combined in many ways.

3 panel solutions



Thule Sun Blockers G2

- Protect against sun
- Micro-Aired screen fabric
- Front and side panels



Thule Rain Blockers G2

- Protect against rain
- Top-quality PVC
- Front and side panels



Thule Windscreen

- Protects against wind
- Micro-Aired screen fabric
- Side panel

› Thule Smart Panels advantages



Easy and quick installation

- Front panels slide into the awning lead rail
- Side panels slide into the new aluminium rafter between the awning's cassette and lead rail
- Smart connections to combine the Rain Blocker G2 panels

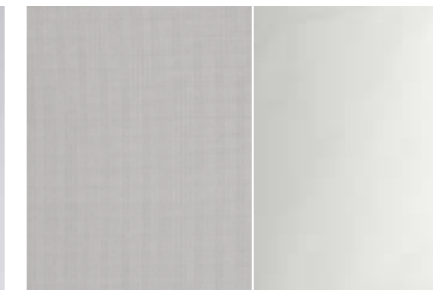

Durable and innovative fabric material

- The sun blockers are made from Micro-Aired screen fabric
- The rain blockers are made from top-quality PVC
- New Thule look in grey and black



Modular system

- Many possibilities to combine the different panels
- The combination of a panel with the QuickFit or EasyLink tent is possible
- Side panels can be installed at both sides of the awning
- Rain Blocker G2 panels can be combined with smart connections



New

Thule Sun and Rain Blockers G2

Easily create your own privacy

AWNING FIXATION



Perfect protection:
against sun, rain or wind

New stylish Thule look:
light grey and Thule black

+ 100% modular:
combine them to fulfill
your needs

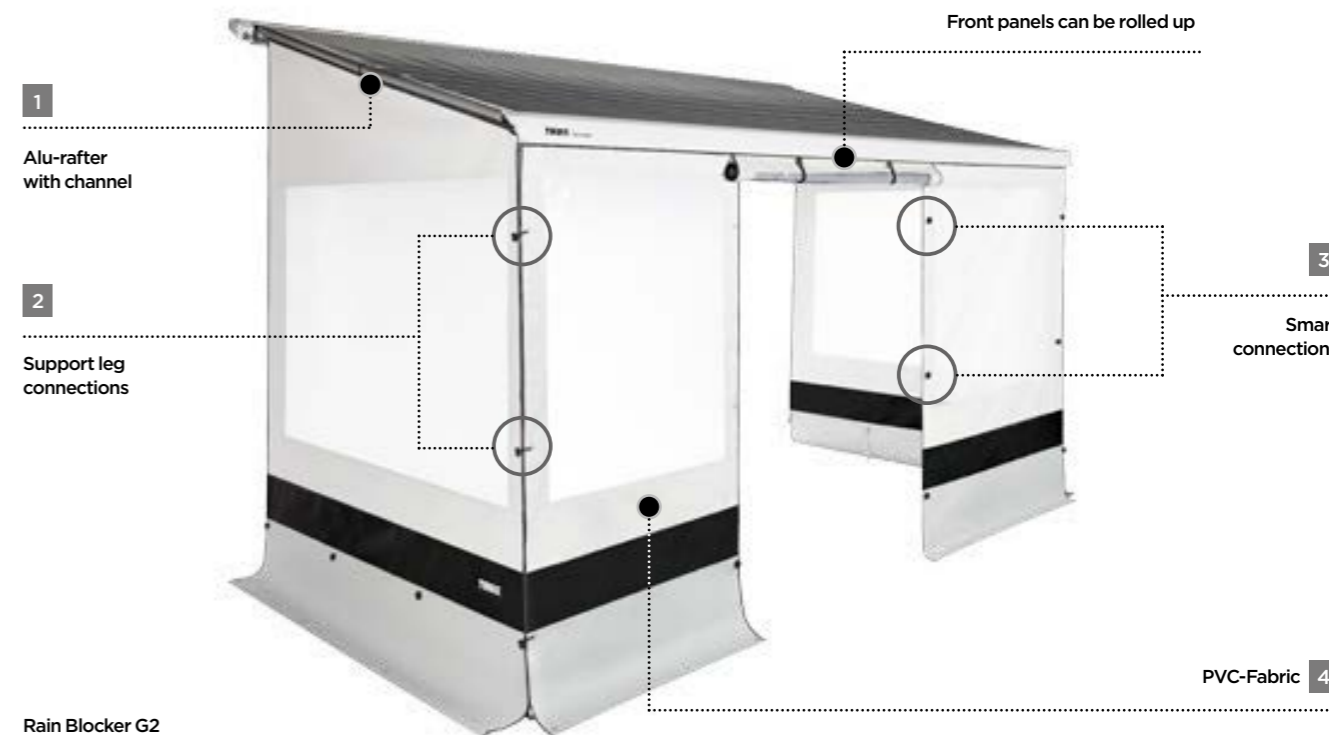

Modular system. The different panels can easily be combined to your needs.



Sun Blocker G2



Rain Blocker G2



Sun + Rain Blocker G2

See more information on www.thule.com

Easy and quick installation. The front panels slide easily into the lead rail of the awning. The side panels can be mounted onto your awning with a new aluminium rafter between the awning's cassette and lead rail. The panel just slides into the rail opening.



Durable fabric material.

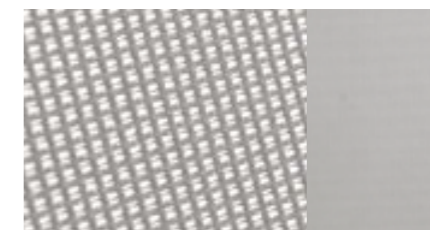

Sun Blocker: Micro-Aired screen fabric protects against the sun while letting the light in



Rain Blocker: PVC-fabric

Thule Sun and Rain Blockers Overview

+ Side panels: can be installed at both sides

AWNING FIXATION



New **Thule Sun Blocker G2.** Lets the breeze in while keeping the sun out, without losing your view

Thule Sun Blocker G2 - Front Panel



- Micro-Aired fabric
- Slides into the awning lead rail
- Fits all Thule Omnistor awnings

	Height	Ref.
SB G2 Front 1.00m	1.70m	• 307284
SB G2 Front 2.40m	1.70m	• 307285
SB G2 Front 2.80m	1.70m	• 307286
SB G2 Front 3.30m	1.70m	• 307287
SB G2 Front 3.80m	1.70m	• 307288
SB G2 Front 4.30m	1.70m	• 307289
SB G2 Front 4.80m	1.70m	• 307290

Thule Sun Blocker G2 - Side Panel



- Micro-Aired fabric
- Slides into a new aluminium rafter between the awning's cassette and lead rail
- Can be installed at both sides

	Projection	A-Mounting Height	Ref.
SB G2 Side Medium	2.50m	2.25 > 2.44m	• 307278
SB G2 Side Large	2.50m	2.45 > 2.64m	• 307279
SB G2 Side Medium TO6900/8000	2.75m	2.25 > 2.44m	• 307280
SB G2 Side Large TO6900/8000	2.75m	2.45 > 2.64m	• 307281
SB G2 Side Medium TO9200	3.00m	2.25 > 2.44m	• 307282
SB G2 Side Large TO9200	3.00m	2.45 > 2.64m	• 307283

New **Thule Rain Blocker G2.** Protects against wind and rain while keeping the incidence of light thanks to the large windows

Thule Rain Blocker G2 - Front Panel



- Top-quality PVC fabric
- Slides into the awning lead rail
- Different panels can be combined with smart connections
- Fits all Thule Omnistor awnings

	Height	Ref.
RB G2 Front 1.00m	2.30m	• 307303
RB G2 Front 1.50m	2.30m	• 307304
RB G2 Front 1.75m	2.30m	• 307305
RB G2 Front 2.00m	2.30m	• 307306

Thule Rain Blocker G2 - Side Panel



- Top-quality PVC fabric
- Slides into a new aluminium rafter between the awning's cassette and lead rail
- Different panels can be combined with smart connections
- Can be installed at both sides

	Projection	A-Mounting Height	Ref.
RB G2 Side Small	2.50m	2.05 > 2.24m	• 307291
RB G2 Side Medium	2.50m	2.25 > 2.44m	• 307292
RB G2 Side Large	2.50m	2.45 > 2.64m	• 307293
RB G2 Side X-Large	2.50m	2.65 > 2.84m	• 307294
RB G2 Side Medium	2.75m	2.25 > 2.44m	• 307295
RB G2 Side Large	2.75m	2.45 > 2.64m	• 307296
RB G2 Side X-Large	2.75m	2.65 > 2.84m	• 307297
RB G2 Side Medium	3.00m	2.25 > 2.44m	• 307298
RB G2 Side Large	3.00m	2.45 > 2.64m	• 307299
RB G2 Side X-Large	3.00m	2.65 > 2.84m	• 307300
RB G2 Side TO1200	2.50m	2.25 > 2.49m	• 307301
RB G2 Side TO6200-Ducato	2.50m	2.30 > 2.50m	• 307302

Thule Sun and Rain Blocker G1 - Front Panel



- Non-transparent PVC fabric
- Slides into the awning lead rail
- Fits all Thule Omnistor awnings

	Height	Ref.
S+R B G1 Front 2.40m	1.40m	• 307588
S+R B G1 Front 2.80m	1.40m	• 307592
S+R B G1 Front 3.30m	1.40m	• 307594
S+R B G1 Front 3.80m	1.40m	• 307596
S+R B G1 Front 4.30m	1.40m	• 307598
S+R B G1 Front 4.80m	1.40m	• 307600

See more information on www.thule.com

Thule Windscreen Even more privacy

+ Fits all types of vehicle and awnings

WALL FIXATION



Modular installation. The Thule Windscreen is easy and quick to set up thanks to its automatic roll in and out system. It can be fixed to your vehicle via wall fixation or into the caravan rail. Unroll it and pair it either to your awning leg (see picture) or make it free standing with the strap kit delivered with the product.



Smart innovation. The Thule Micro-Aired system lets the light and breeze in while keeping the elements out and ensuring privacy. It allows the fabric to "breathe" while being strong enough to prevent any danger of wind damage.



Roll in/out system
This unique automatic system offers effortless opening and automatic closing of your Windscreen

EASY STORAGE

The Thule Windscreen is delivered with a bag for easy storage and space-saving.



INFO

- Total height: 1.55m
- Fabric's height: 1.40m
- Length: up to 3m extension
- Weight: 4.5kg
- 306456

> Tents



> Why does a Thule awning tent offer you more?



- 1** Awning can easily be used separately without an awning tent
- 2** Easier and faster to install than a traditional tent
- 3** Variety of solutions for different travel behaviour
- 4** Customisation of the space under your awning to your needs

> Thule tent advantages



- Easy installation**
- Open the awning = tent roof
 - Attach the tent to the awning structure



- Stability and security**
- High quality textile for different tent applications (Airtex, Ripstop,...)
 - Awning structure in combination with tent installation profiles for a high sturdiness
 - Tested in various weather conditions





- Innovative and high quality design**
- Contemporary design in line with the awning design
 - Large windows invite maximum light and create an extra feeling of spaciousness
 - Clever innovations : integrated curtains - clamping profiles...
 - Permanent ventilation



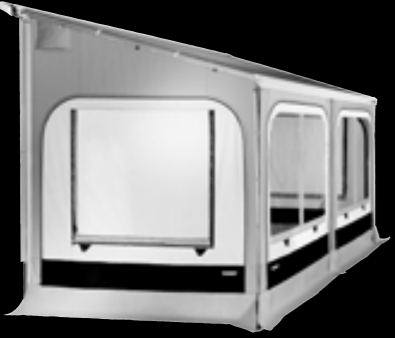

- Modularity**
- Tent can be installed completely but separate parts can be removed
 - Individual sides can be installed such as sun and rain blockers

> Whatever your lifestyle and vehicle, find the Thule tent you need!

You want to have a **long stay**

	Motorhome	Caravan	Van	Awning fit	Set-up time compared to traditional tent	Fabric	Maximum length	Mounting height	Weight for 4.00m Large	Curtains	Windslip	Bag
Thule Panorama  See p.36 <ul style="list-style-type: none"> • High quality materials in a timeless design • Easy installation and user-friendly • Large windows offer a panoramic view • High sturdiness and extremely high stability ALL IN <ul style="list-style-type: none"> • Thule Windslip • 2 luxury bags 	•	•	• Ducato	Thule Omnistor • 8000 • 5003 • 5002 • 5500 • 9200 • 6900 • 6200 • 6002	Fast	Innovative AIRTEX® fabric	6.00m	2.30m 2.75m	32.2kg	Optional	Included	Luxury bag
Thule Residence G2  See p.38 <ul style="list-style-type: none"> • High quality fabric • User-friendly and modular • Living space up to 17.40m² • Large windows invite maximum light ALL IN <ul style="list-style-type: none"> • Classic bag 	•	•	• VW TS	Thule Omnistor • 8000 • 5003 • 5102 • 4900 • 5500 • 5002 • 6002 • 9200 • 6200 • 6900	Fast	Long-lasting PVC fabric	6.00m	2.15m 3.10m	28.6kg	Optional	Optional	Classic bag / Luxury bag (Option)

You want to have a **short stay**

Thule QuickFit  See p.40 <ul style="list-style-type: none"> • Universal awning tent • For awnings with a projection from 2.50m • Only 15 minutes to set up and ultra-light • Double roof to create a better ventilation • Two permanent ventilation openings ALL IN <ul style="list-style-type: none"> • Thule Windslip and Wheelcover • Curtains • Sport bag 	•	•	• Ducato	Thule Omnistor • 8000 • 5003 • 4900 • 5500 • 5002 • 6002 • 9200 • 6200 • 6900 • 1200 + other brands	Ultra-fast	Innovative RIPSTOP fabric	3.60m	2.25m 2.84m	20kg	Included	Included	Sport bag
Thule EasyLink  See p.42 <ul style="list-style-type: none"> • Universal awning tent • For awnings with a projection from 2.25m • Easy and fast installation • Sloping front panel • Double roof to create a better ventilation ALL IN <ul style="list-style-type: none"> • Thule Windslip and Wheelcover • Curtains • Sport Bag 	•	•		Thule Omnistor • 8000 • 5003 • 4900 • 5002 • 5500 • 9200 • 6900 • 6200 • 6002 • 1200 • Caravan Style + other brands	Ultra-fast	Innovative RIPSTOP fabric	3.60m	2.25m 2.55m	14.3kg	Included	Included	Sport bag

Thule Panorama

See p.36



Thule QuickFit

See p.40



Thule Residence G2

See p.38



New

Thule EasyLink

See p.42



Thule Panorama

High comfort, clever innovations

LONG STAY



Modularity:
customised to
your needs

New for Ducato:
special model for
Ducato

+ Panoramic view:
more luminosity and
comfort



New

Thule Mosquito. Optional zippable mosquito screens to keep dirt and vermin out. Creates an optimal ventilation. Easy to clean.
• For all models
• For $\geq 4m$ front and sides

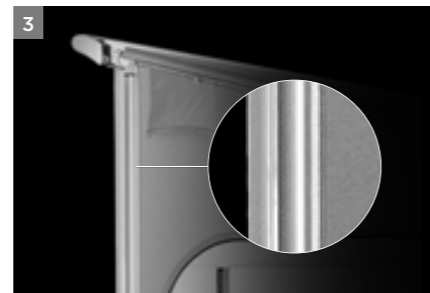

Clamping profile. A clamping profile ensures mounting and connection of the side panel to the awning fabric. It's the perfect roof sealing. The side panels slide into the clamping profile for easy installation.

Quick installation. The front and side panels simply slide into rails and ensure a quick installation. Front and side panels are combined with a zipper.

High sturdiness. Thanks to a diagonal support between the mast and the clamping profile, the tent offers extremely high stability. A double rubber flap attached to the mast profile ensures full sealing with the vehicle wall.

Innovative fabric material. AIRTEX® is a 100% polyester fabric coated on one side with acrylate and impregnated with a finish based on Teflon. The fungicide finish prevents the development of fungus and mildew. The fabric absorbs almost no moisture and provides optimal water tightness. It is very low-maintenance and washable.



See more information on www.thule.com

Front panel design. Depending on your awning's size, the front panel design of the tent varies but with no compromise on luminosity and comfort. The large windows offer you a stunning 180° panoramic view.

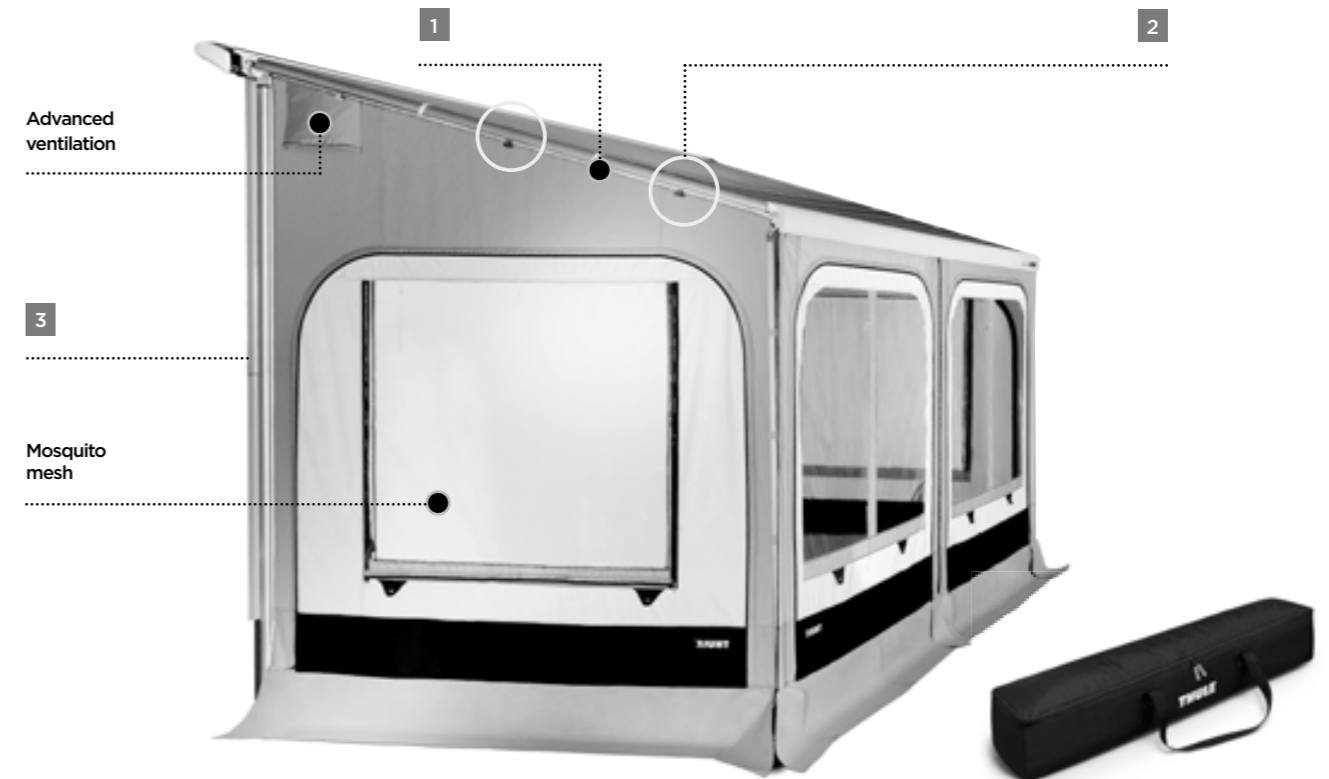
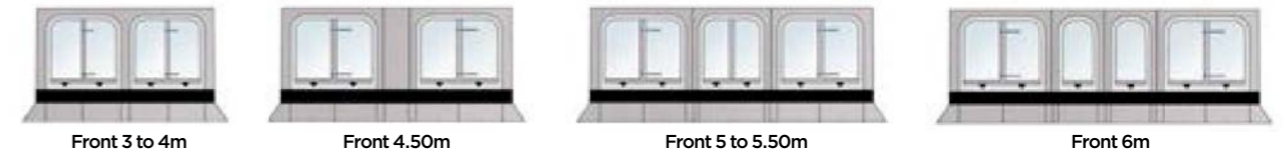

Modularity. The Thule Panorama is completely adaptable to satisfy all your needs. You can fully remove the large front windows. You can also open them vertically to use as a door, or open them horizontally to let the fresh air in. The tent panels can also be used as sun and rain blockers to protect you from sun, rain and wind.



FITS

- Thule Omnistor 8000 - 5003 - 5500 - 5002 - 9200 - 6200 - 6900 - 6002
- Maximum length: 6.00m

ACCESSORIES

- Thule Curtains • Thule Mosquito - See p.44

ALL IN

- Thule Windslip: prevents the wind from entering through the gap below your vehicle
- 2 luxury bags to store: the pegs, the clamping profiles, the tent...

MODELS

Model	A - Mounting height
Medium	2.30m > 2.44m
Large	2.45m > 2.59m
X-Large	2.60m > 2.74m
Ducato	2.30m > 2.50m

A = measured from ground to bottom of awning cassette / Weight for a 3.00m Medium: 29.50kg - Weight for a 6.00m Large: 35.50kg

Thule Residence G2

A real living room in the outdoors

LONG STAY



Robust insulation

Special model for VW T5 to fit the Thule Omnistor 5102

+ Living space up to: **17.4m²**



Front panel design. Depending on your awning's size, the front panel design of the tent varies. Large windows invite maximum light and create an extra feeling of spaciousness.



Front 3 to 3.75m



Front 4 to 5.50m

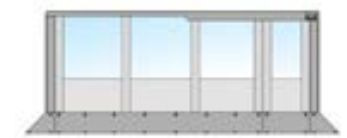

Front 6m



Clamping profile. A clamping profile ensures mounting and connection of the side panel to the awning fabric. It's the perfect roof sealing. The side panels slide into the clamping profile for easy installation.

Easy installation. This tent offers extremely high stability while being quick and easy to install: the front panel simply slides into the lead rail of the awning and a clamping profile ensures mounting and connection of the side panel to the awning fabric.

Robust insulation. A double rubber flap attached to the mast profile ensures full sealing with the vehicle wall.



Modularity. Side windows can be fully opened. The front panel rolls up completely. Available with door on the left or right side.

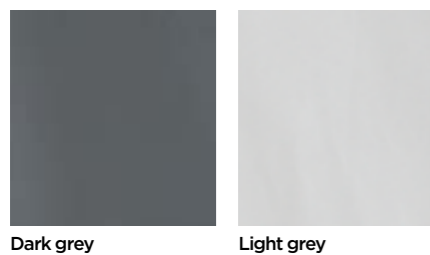

Fabric. High quality PVC fabric for optimum wind and water tightness.
 • The front panel can be customised to your awning fabric: 03 - 04 - 31- 32 - 22

See more information on www.thule.com

FITS

- Thule Omnistor 8000 - 5003 - 4900 - 5500 - 5002 - 5102 - 9200 - 6200 - 6900 - 6002
- Awnings from 3m to 6m

ACCESSORIES

- Thule Curtains
- Thule Windslip; prevents the wind from entering through the gap below your vehicle
- Thule Luxury Bag
See p.44

ALL IN

- A bag to store the pegs, the tent tubes, the tent...

NOTE

- Front and side panels need to be ordered separately

MODELS

Model	A - Mounting height
Small	2.15m > 2.29m
Medium	2.30m > 2.44m
Large	2.45m > 2.59m
X-Large	2.60m > 2.74m
XX-Large	2.75m > 2.89m
XXX-Large	2.90m > 3.10m

A = measured from ground to bottom of awning cassette / Weight for a 3.00m Medium: 27.00kg - Weight for a 6.00m Large: 33.50kg

Thule QuickFit

Ultra-fast set up

Modularity:
fully zippable panels

Design:
contemporary look

+ Fast set up:
15 min. only

SHORT STAY



New

Thule Mosquito. Optional zippable mosquito screens to keep dirt and vermin out. Creates an optimal ventilation. Easy to clean.
• For all models
• For front and sides

Fast and easy set up. The complete tent is in one piece and doesn't need profiles. It easily slides into the caravan rail or the additional rail below the awning cassette, and is fixed to the front rail of the awning. The front canopy is installed with flexible arch tubes. All fastening points have been thought through to enhance the installation.



Curtains with zippers

Modularity. All sides are fully zippable: can be taken away to create an open porch, can be opened side-ways to create a door on all sides, left or right, can be opened from top to bottom to create an open window.

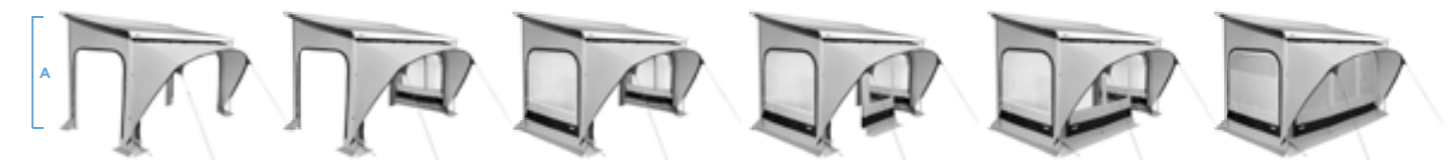

Light and robust structure. The tent is ultra-light from 16 to 19kg depending on the size.

Double roof. The double ceiling is created by suspending the tent below the cassette awning. It creates a better ventilation and insulation.

Permanent ventilation. The tent has two permanent ventilation openings in order to reduce condensation.

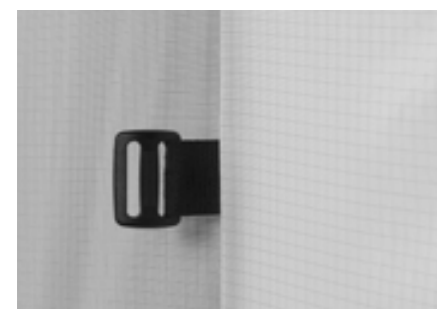

Innovative fabric. It is made out of Ripstop fabric: a lightweight woven and tear-resistant material used for aeronautical engineering. Not to mention that this material also has a strong water resistant coefficient. Because it's connected with an awning, the double roof offers a good insulation to keep the tent and vehicle cool.

INSTALLATION

- Universal fitting on most awning types
- Slides into the awning rail of a caravan or into an optional QuickFit rail:
- for roof awning 6200/9200 • 307050
- for wall mounted awnings • 307205 - 307206



FITS

- Thule Omnistor 8000 - 5003 - 4900 - 5500 - 5002 - 9200 - 6200 - 6900 - 6002 - 1200 + other brands
- Maximum length: 3.60m

ACCESSORIES

- Thule Mosquito
- Thule Side Tensioning Kit
- Thule Projection Kit
- See p.44

ALL IN

- Thule Windslip: prevents the wind from entering through the gap below your vehicle
- Curtains with zippers
- A bag to store: the pegs, the arch tubes, the tent...

MODELS

Model	A - Mounting height	Min. awning length
2.60m Medium	2.25m > 2.44m	3.00m
3.10m Medium	2.25m > 2.44m	3.50m
3.60m Medium	2.25m > 2.44m	4.00m
2.60m Large	2.45m > 2.64m	3.00m
3.10m Large	2.45m > 2.64m	3.50m
3.60m Large	2.45m > 2.64m	4.00m
2.60m X-Large	2.65m > 2.84m	3.00m
3.10m X-Large	2.65m > 2.84m	3.50m
3.60m X-Large	2.65m > 2.84m	4.00m
3.00m Ducato	2.30m > 2.50m	3.25m

See more information on www.thule.com

A = measured from ground to tent rail / Weight for a 2.60m Medium: 15.70kg - Weight for a 3.60m X-Large: 18.40kg

New

Thule EasyLink

Universal lightweight awning tent

SHORT STAY



Universal fitting
on awnings with a
projection from 2.25m

**Easy and
fast installation**

+ Ultra-light:
12.2kg



Double roof. The double ceiling is created by suspending the tent below the cassette awning. It creates a better ventilation and insulation.

Ventilation. Side windows are completely in mosquito mesh to keep dirt and vermin out, and create an optimal ventilation. The windows are covered with external blinds with zippers.

Design. The tent is ultra-light from 12.2 to 14.3kg depending on the size. It has a timeless design thanks to the combination of black, grey and white.

Innovative fabric. It is made out of Ripstop fabric: a lightweight woven and tear-resistant material used for aeronautical engineering. Not to mention that this material also has a strong water resistant coefficient. Because it's connected with an awning, the double roof offers a good insulation to keep the tent and vehicle cool.

INSTALLATION

- Universal fitting on most awning types
- Slides into the awning rail of a caravan or into an optional EasyLink rail:
- for roof awning 6200/9200 • 307050
- for wall mounted awnings • 307205 - 307206

See more information on www.thule.com

Very easy and fast to set up. The tent fits perfectly the awning structure and doesn't need additional profiles. It easily slides into the caravan rail or the additional rail below the awning cassette and is fixed to the front rail of the awning.



Sloping front panel.
Offers a large internal living surface of maximum 2.50m x 3.60m

Modularity. Front panel with integrated doors at both sides. The front panel can be rolled up completely.



FITS

- Thule Omnistor 8000 - 5003 - 4900 - 5500 - 5002 - 9200 - 6200 - 6900 - 6002 - 1200 - Caravan Style + other brands
- Maximum length: 3.60m

ACCESSORIES

- Thule Side Tensioning Kit
- Thule Projection Kit

See p.44

ALL IN

- Thule Windslip: prevents the wind from entering through the gap below your vehicle
- Curtains with zippers
- A bag to store: the pegs, the tent...

MODELS

Model	A - Mounting height	Min. awning length
2.60m	2.25m > 2.55m	3.00m
3.10m	2.25m > 2.55m	3.50m
3.60m	2.25m > 2.55m	4.00m

A = measured from ground to tent rail / Weight for a 2.60m: 12.20kg - Weight for a 3.60m: 14.30kg

Thule Tent Accessories

It's all in the details

+ Complete your tent to your needs



Suitable for Thule Panorama and Thule Residence G2



New

Thule Mosquito
Zippable mosquito screen to keep dirt and vermin out. Creates an optimal ventilation. Easy to clean.

- Suitable for Thule Panorama
- For all models
- For ≥ 4m front and sides



Thule Curtains

- Available in blue and grey
- Available in different sizes



Thule Windslip
Prevents the wind from entering through the gap below your vehicle.



Thule Luxury Bags
For storing your Thule tent - Set contains 1 large bag (20x30x120cm) and 1 smaller bag (20x20x120cm).

- Made from high quality polyester fabric
- 307891



Thule Hold Down Side Strap Kit
This kit prevents the awning and tent from being damaged due to high wind. The kit is attached to the support legs and can easily be used in combination with a Thule tent or Thule Smart Panels.

- 307916

See more information on www.thule.com

Suitable for Thule QuickFit and Thule EasyLink



New

Thule Mosquito
Zippable mosquito screen to keep dirt and vermin out. Creates an optimal ventilation. Easy to clean.

- Suitable for Thule QuickFit
- For all models
- For front and sides



Thule Projection Kit
8 buckles with strap to mount the Thule QuickFit/EasyLink tent to awnings with a projection from 2.75 to 3.00m.

- 307052



Thule Side Tensioning Kit
2 sets of fiberglass poles for a better sealing of the Thule QuickFit/EasyLink tent with the wall of the vehicle.

- 307053

Thule Mounting Options

	Roof	Wall	Caravan Rail
For Caravan	<p>Original caravanrail All Roof Awnings</p>	<p>Universal Tent Fixation Rail • 307205 - White rail • 307206 - Anthracite rail All Awnings</p>	<p>Tent Fixation Kit TO 1200 • 307063 Only TO 1200</p>
For Motorhome - Van	<p>Universal Tent Fixation Rail • 307205 • 307206 All Roof Awnings</p>	<p>Universal Tent Fixation Rail • 307205 / 307206 All Wall Awnings</p>	<p>Universal Tent Fixation Rail • 307205 • 307206 All Awnings</p>

NOTE - Awning Fixation Kit F: 8 fixation parts to mount the Thule QuickFit/EasyLink tent on Fiamma awnings - 307061

> Storage



> Why choose the Thule Storage Solutions?

Space is always too tight, therefore a flexible storage is mandatory. It allows you to have a place for each item and easy access to it. With our smart organizers and boxes you can store your things inside or outside to fully enjoy your free time.

> Thule Storage advantages

In order to easily store your belongings, we offer different kinds of organizers. These clever solutions help you keep a range of essential items at hand's reach.



Easy to use

- Lots of different storage compartments
- Integrated carry handles for easy transport
- Foldable for compact storage when not in use



Water resistant

- Made from 100% polyester
- Durable and strong material
- Weather and water resistant



Practical

- Your belongings at hand's reach
- To be used inside or outside your vehicle
- Different hanging options

> Whatever your needs, find the right Thule Storage Solution!

			Foldable	Capacity	Application	Water resistant	Size
You have a Motorhome, a Caravan or a Van   	Soft storage						
	Thule Go Box	p.48	•	M = 65L / L = 80L	Indoor/outdoor	•	61x36x30cm 61x46x30cm
	Thule Toiletry Kit	p.48	•	13 pockets	Indoor/outdoor	•	40x35cm
	Thule Wall Organizer	p.48	•	14 pockets	Indoor/outdoor	•	85x50cm
	Thule Shoe Organizer	p.48	•	10 pair	Indoor/outdoor	•	80x55cm
	Thule Countertop Organizer	p.49	•	Various	Indoor/outdoor	•	40x90cm
	Thule Trash Bin	p.49	•	50L	Indoor/outdoor	•	35x35x70cm
Hard storage							
New	Thule Touring	p.50		330L - 420L	Roof top	•	139x90x40cm 196x78x43cm
	Thule Top Box	p.51		375L - 500L	Roof top	•	134x94x43cm 187x89x40cm
	Thule Carry All Box	p.51		450L	Rear wall	•	147x53x69cm

Thule Storage Solutions

Timeless design in black and grey

Technical outdoor fabric:
water resistant

Practical:
integrated carry handles

+ Use the new Thule Hanging Systems

FLEXIBLE STORAGE



New

Thule Hanging Systems

To easily mount your organizers, Thule created different hanging systems.



Thule Go Box

- 2 main compartments, 3 side pockets
- It is simple to carry and folds up quickly to store when not being used
- The foldable cap offers absolute rain protection with no extra weight



INFO

- Technical outdoor fabric - water resistant
- Medium: 61x36x30cm - 306929
- Large: 61x46x30cm - 306930

Thule Wall Organizer

- Provides storage space for all kinds of things
- 14 pockets in 2 different sizes
- Integrated cover with zipper to protect items during transport



INFO

- 85x50cm
- Technical outdoor fabric - water resistant
- 306924

Fixation:

- Thule Strap Kit for Organizers (not included)
- Thule POD 2.0 (not included)

Thule Countertop Organizer

- Keeps all essential items within reach
- Different compartments and elastic loops
- Integrated paper towel holder

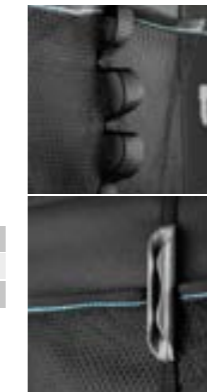

INFO

- 40x90cm
- Technical outdoor fabric - water resistant
- 306926

Fixation:

- Thule Strap Kit for Organizers (not included)
- Thule POD 2.0 (not included)



Thule Toiletry Kit

- Ideal to use in the bathroom
- 13 separated compartments
- Easy to carry thanks to the handle on top



INFO

- Closed: 40x35cm - open: 120x35cm
- Technical outdoor fabric - water resistant
- 306928

Fixation:

- L-shaped hook - fits over doors

Thule Shoe Organizer

- Ideal to store 10 pair of shoes
- 10 large and 2 mesh pockets
- Small ventilation holes ensure fresh air
- Integrated cover with zipper



INFO

- 80x55cm
- Technical outdoor fabric - water resistant
- 306925

Fixation:

- Thule Strap Kit for Organizers (not included)
- Thule POD 2.0 (not included)



Thule Trash Bin

- Keeps your waste or laundry out of sight and off the ground
- Suitable for trash bags of 50L
- A zipper at the bottom makes it easy to empty and clean



INFO

- 35x35x70cm
- Technical outdoor fabric - water resistant
- 306927

Fixation:

- Thule POD 1.0 (not included)

Thule Strap Kit for Organizers

- Fits in the caravan rail or the lead rail of your awning
- Maximum load: 10kg/strap
- Quick release system
- Black - set of 2 pieces
- 307124



Thule POD 2.0

- Mounted with 2 screws
- New design, compact and discrete
- Maximum load: 10kg/POD
- White - set of 2 pieces
- 55x30x12mm
- 306804

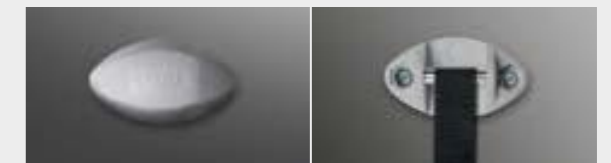

Thule POD 1.0

- Mounted with 2 screws
- Cover included
- White - set of 2 pieces
- 88x52x44mm
- 307620

See more information on www.thule.com

New

Thule Touring

The functional roof box

+ Capacity: **330L - 420L**

TOP MOUNTING

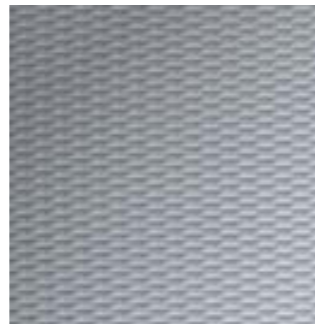

FastClick. Patented FastClick quickmount system with integrated torque indicator for simple and secured fixing. Tighten grip claws around load bars by turning the knobs. Easy to switch from your RV to your car.

Dual-Side. Enables the box to be opened from both sides of the roof. This does not only mean easy loading and access to the load, but also facilitates mounting of the roof box.

Central locking. This roof box has several locking points for maximum safety and theft protection. The central locking feature means that the key can only be removed if all locking points are securely closed.

Titan Aeroskin. Intelligent design. The unique aeroskin material texture gives an extravagant look and is more resistant to scratches.

Thule Touring 100



INFO

- Volume: 330L
- Weight: 10kg
- 139x90x40cm
- Load capacity: 50kg
- Material: titan aeroskin
- 634100

Thule Touring 780



INFO

- Volume: 420L
- Weight: 15kg
- 196x78x43cm
- Load capacity: 50kg
- Material: titan aeroskin
- 634800

2 DIFFERENT MOUNTING OPTIONS • FastClick mounting system (standard) • With T-track adapter - 306680 / With T-track adapter + mounting rack - 306681 (only needed for flat mounted crossbars)

See more information on www.thule.com

Thule Top Box

Smart and robust

+ Capacity: **375L - 500L**

TOP MOUNTING

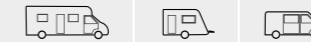

The Thule Top Box is easy to open and close thanks to the integrated handle and comes complete with a watertight and rustproof lock. Made of very solid ABS+ reinforced with an aluminium frame on the inside, it is shock-absorbent and weather resistant and has a rubber seal to ensure there is no water ingress.

Thule Top Box 130



- Volume: 375L
- Weight: 15kg
- 134x94x43cm
- Material: white ABS+
- 307609

Thule Top Box 190



- Volume: 500L
- Weight: 20kg
- 187x89x40cm
- Material: white ABS+
- 307610

2 DIFFERENT MOUNTING OPTIONS

- With mounting rack - 307894
- With mounting bridges - 307893

Thule Carry All Box

Huge volume

+ Capacity: **450L**

REAR MOUNTING



Spacious and sturdy. The Thule Carry All Box is extremely user-friendly thanks to its mounting height. The box can either be mounted on a 3 bikes bike carrier, or onto the special carrier frame directly on the rear panel. The luggage is protected by an elastic net.

NOTE

When mounted onto a bike carrier, the maximum load capacity is determined by the maximum load capacity of the bike carrier minus the weight of the box.

- Volume: 450L
- Weight: 22kg
- 147x53x69cm
- Material: white ABS+
- 307606

2 DIFFERENT MOUNTING OPTIONS

- On a bike carrier
- On a mounting frame - 308138

➤ Bike





› Why choose a Thule Bike Carrier?

Whatever your vehicle, its size and its weight, and whatever your bike, from cyclo-cross to electric, the large range of Thule Bike Carriers covers all your needs.



**A leading brand
in bike carriers
for years**

› Thule Bike Carrier advantages

Thule bike carriers stand for extreme stability, premium quality and superior product safety. Each bike carrier has smart innovative features that are unique in the market making them easy to use and simple to install. And on top of that, they look great on your vehicle.

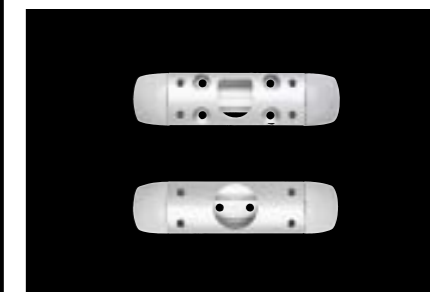
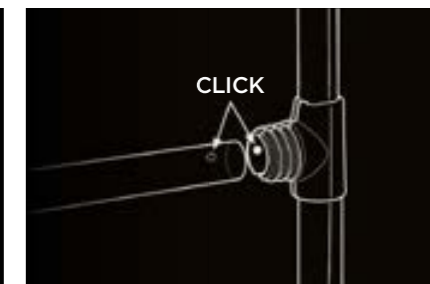

Ease of use - smart features

- Bike holders: easy to change position, soft touch, for any type of bikes, built-in security locks - See p.58
- Wheel holders: perfect fit, easy slide from left to right, wheel straps with pump buckle - See p.58
- Extendable: add easily an extra rail for a 3rd or 4th bike - See p.58
- Adjustable Tilt-Stop system: easy access to the front locker of a caravan thanks to the adjustable tilt angle - See p.66

Most aesthetic product design

- Appealing design
- Stylish anodised aluminium
- Non glossy black plastic parts
- Perfect fit with any type of vehicle

Ease of installation

- Many pre-assembled parts ensure a faster installation
- Fast click connections make the installation very easy
- Large range of adapters available, developed in cooperation with and approved by the recreational vehicle manufacturers

› Thule Bike Carrier safety

All our bike carriers are made of top quality aluminium that combines optimal robustness and lightness.



Thule Test Center

- With the Thule Test Program™ as part of the development process, Thule products are tested to the highest standards in the industry

High quality materials

- Made from the highest quality materials that last over time
- Extra strong aluminium guarantees stability and reliability
- Durable and weatherproof

Product safety features

- Safe and easy platform lock - See p.66
- Lockable platform to avoid movement during transport - See p.58



TUV Approved

TÜV Rheinland is the leading provider of product testing and certifications for worldwide marketplace. TÜV Rheinland specialists certify safety and quality.

> Whatever your vehicle, find the right Thule Bike Carrier you need!

You have a **Motorhome**



REAR WALL

GARAGE



Thule Excellent
2 models
See p.58



Thule Elite G2
2 models
See p.60



Thule Sport G2
5 models
See p.62



Thule Lift
2 models
See p.68



Thule Sport G2 Garage
1 model
See p.62

		Standard number of bikes	Max. number of bikes (optional)	Max loading weight	Maximum bike weight	For E-bikes	Sliding Rail left - right	Sliding Rail in depth	Lockable platform	Bike holders	Weight
REAR WALL											
Thule Excellent	p.58	2	4	60kg	30kg	•	•	•	Automatic	With locks	10.6kg
Thule Elite G2	p.60	2	4	60kg	30kg	•	•		Manual	Optional with lock	9.5kg 10.1kg
Thule Sport G2	p.62	2	3	50kg 38kg	19kg		•		Manual	Optional with lock	6.8kg 8.2kg
Thule Lift	p.68	2	3	50kg	19kg		•			Optional cable lock	15.5kg 16kg
GARAGE											
Thule Sport G2 Garage	p.63	2	4	50kg	19kg	•	•			Optional with locks	5.6kg

You have a **Caravan**



A-FRAME

REAR WALL



New
Thule Caravan Superb 2 models
Thule Caravan Smart 1 model
See p.66



Thule Caravan Light
1 model
See p.66



Thule Excellent
2 models
See p.58



Thule Elite G2
2 models
See p.60



Thule Sport G2
5 models
See p.62



Thule Lift
2 models
See p.68

		Standard number of bikes	Max. number of bikes (optional)	Max loading weight	Maximum bike weight	For E-bikes	Sliding Rail left - right	Sliding Rail in depth	Lockable platform	Bike holders	Weight	
A-FRAME												
New	Thule Caravan Superb	p.66	2	3	60kg	30kg	•			Manual	With locks	9.5kg 9.7kg
	Thule Caravan Smart	p.66	2	2	50kg	30kg	•			Manual	Optional with locks	8.9kg
	Thule Caravan Light	p.66	2	2	40kg	20kg					Straps	4.7kg
REAR WALL												
	Thule Excellent	p.58	2	4	60kg	30kg	•	•	•	Automatic	With locks	10.6kg
	Thule Elite G2	p.60	2	4	60kg	30kg	•	•		Manual	Optional with lock	9.5kg 10.1kg
	Thule Sport G2	p.62	2	3	50kg 38kg	19kg		•		Manual	Optional with lock	6.8kg 8.2kg
	Thule Lift	p.68	2	3	50kg	19kg		•			Optional cable lock	15.5kg 16kg

You have a **Van**

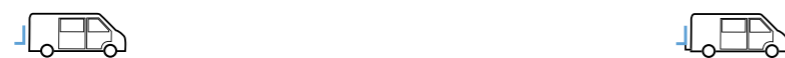

REAR DOORS

TOW BAR



Thule Elite G2 Van
1 model
See p.64



Thule Sport G2 Van
1 model
See p.64



Thule Sport G2 2 doors
1 model
See p.64



New
Thule EasyFold
1 model
See p.69



Thule EuroClassic G6
2 models
See p.69



Thule EuroWay G2
2 models
See p.69

		Standard number of bikes	Max. number of bikes (optional)	Max loading weight	Maximum bike weight	For E-bikes	Sliding Rail left - right	Sliding Rail in depth	Lockable platform	Bike holders	Weight	
REAR DOORS												
	Thule Elite G2 Van	p.64	2	2	35kg	19kg		•		Manual	Optional with lock	9.5kg
	Thule Sport G2 Van	p.64	2	2	35kg	19kg		•		Manual	Optional with lock	9.5kg
	Thule Sport G2 2 doors	p.64	2	3	50kg	19kg		•		Manual	Optional with lock	7.3kg
TOW BAR												
New	Thule EasyFold	p.69	2	2	60kg	30kg	•			Automatic	With locks	17.1kg
	Thule EuroClassic G6	p.69	2	4	51kg 60kg	25kg				Automatic	With locks	17.6kg 20.7kg
	Thule EuroWay G2	p.69	2	3	46kg 51kg	24kg				Automatic	With locks	13.4kg 16.5kg

Thule Excellent

100% innovation. Pure design

Bikes load capacity:
🚲 2 > 3 > 4

Maximum capacity:
60kg

+ Perfect for E-bikes

REAR WALL



Sliding rails. The rails are adjustable in depth and from the left to the right. They easily slide to make sure you find the best position for your bikes without effort.



Wheel holders. Finding the perfect setting for your bike is easy thanks to adjustable wheel holders. They enable you to transport all kinds of bikes with various sizes.



Pump buckles. The Thule wheel straps with pump buckles help you set up your bikes and offer easy and secured fastening of the wheels.



Lockable platform. The platform is locked both in open and closed position to secure your bikes during transportation. This means the platform won't move while you're driving, it is locked automatically.



Bike holders. Adjustable soft-touch bike holders move easily from right to left to align with your bike frame. Your bikes are always secured thanks to the integrated locks.



Thule Excellent - Standard
Recommended for a vertical wall between 80 - 150cm.

LOAD INFO

- 2 bikes extendable to 4
- Weight: 10.6kg
- Max loading weight: 60kg
- Max bike weight: 30kg
- Max bike weight 4th rail: 15kg
- 309821



Thule Excellent - Short
Recommended for a vertical wall between 60 - 80cm.

LOAD INFO

- 2 bikes extendable to 4
- Weight: 10.6kg
- Max loading weight: 60kg
- Max bike weight: 30kg
- Max bike weight 4th rail: 15kg
- 309822

THULE EXTENSION KITS



Thule Excellent 3rd Rail Kit
To position a 3rd bike on the bike carrier. Adjustable in all directions.
• 309823



Thule Excellent 4th Rail Kit
To position a 4th bike on the bike carrier. Fixed outwards and is not adjustable.
• 309824

ACCESSORIES

- Thule Bike Cover
 - Thule Rear Warning Sign
 - Thule Brake Straps
 - Thule Bike Frame Adapter
- See p.70



See more information on www.thule.com or go to YouTube: typing Thule Excellent

Thule Elite G2

The first ever adjustable bike carrier

Bikes load capacity:
🚲 2 > 3 > 4

Maximum capacity:
60kg

+ Suitable for E-bikes

REAR WALL



Sliding rails - left and right. The rails are adjustable from the left to the right. They easily slide to make sure you find the best position for your bikes without effort.

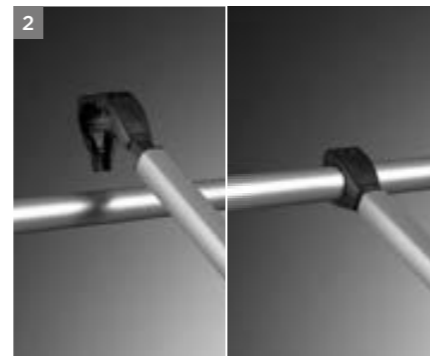

Bike holders. Adjustable soft-touch bike holders move easily from right to left to align with your bike frame. Your bikes can be secured with the optional knobs with lock.

Thule advises when loading your bikes:

- The heaviest must be fixed inwards
- The lightest must be fixed outwards



Lockable platform. The platform is locked both in open and closed position to secure your bikes during transportation. This means the platform won't move while you're driving. The platform is locked manually.



Wheel holders. Finding the perfect setting for your bike is easy thanks to adjustable wheel holders. They enable you to transport all kinds of bikes with various sizes.



Thule Elite G2 - Standard
Recommended for a vertical wall between 80 - 150cm.

LOAD INFO

- 2 bikes extendable to 4
- Weight: 10.1kg
- Max loading weight: 60kg
- Max bike weight: 30kg
- Max bike weight 4th rail: 15kg
- 306560



Thule Elite G2 - Short
Recommended for a vertical wall between 50 - 80cm.

LOAD INFO

- 2 bikes extendable to 4
- Weight: 9.5kg
- Max loading weight: 60kg
- Max bike weight: 30kg
- Max bike weight 4th rail: 15kg
- 306561

THULE EXTENSION KITS



Thule Elite G2 3rd Rail Kit
To position a 3rd bike on the bike carrier.
• 306565



Thule Elite G2 4th Rail Kit
To position a 4th bike on the bike carrier.
• 309824

ACCESSORIES

- Thule Knob with Lock
 - Thule Bike Cover
 - Thule Rear Warning Sign
 - Thule Brake Straps
 - Thule Bike Frame Adapter
- See p.70

See more information on www.thule.com

Thule Sport G2

Created for active lives

REAR WALL - GARAGE



Bikes load capacity:
🚲 2 > 3

Maximum capacity:
38 > 50kg

+ Smart:
**easy to use,
very robust**



1 2



Sliding rails - left and right. The rails are adjustable from the left to the right. They easily slide to make sure you find the best position for your bikes without effort.

Lockable platform. The platform is locked both in open and closed position to secure your bikes during transportation. This means the platform won't move while you're driving. The platform is locked manually.

See more information on www.thule.com

Thule Sport G2 - Standard

For caravan and motorhome rear. Recommended for a vertical wall between 80 and 150cm.



LOAD INFO

- 2 bikes extendable to 3
- Weight: 8.2kg
- Max loading weight: 50kg
- Max bike weight: 19kg
- 307126



Thule Sport G2 - Short

For caravan and motorhome rear. Recommended for a vertical wall between 40 and 70cm.



LOAD INFO

- 2 bikes extendable to 3
- Weight: 7.9kg
- Max loading weight: 50kg
- Max bike weight: 19kg
- 307127



Thule Sport G2 - Universal

Recommended when space is limited by a window or a bumper. Attached under the base of the caravan.



LOAD INFO

- 2 bikes
- Weight: 8kg
- Max loading weight: 38kg
- Max bike weight: 19kg
- 306563



Thule Sport G2 - W.150 / Hobby

To pair with Thule Omnistor W-150 awning. For Hobby caravan since 2004.

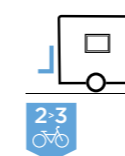

LOAD INFO

- 2 bikes extendable to 3
- Weight: 6.8kg
- Max loading weight: 50kg
- Max bike weight: 19kg
- 307128



Thule Sport G2 - Tour

Can be mounted on a curved rear wall.



LOAD INFO

- 2 bikes extendable to 3
- Weight: 6.8kg
- Max loading weight: 50kg
- Max bike weight: 19kg
- 306572



THULE EXTENSION KITS



Thule Sport G2 3rd Rail Kit
To position a 3rd bike on the bike carrier.
• 306577



Thule E-Bike Rail Kit
• 306945

ACCESSORIES

- Thule Knob with Lock
 - Thule Brake Straps
 - Thule Bike Cover
 - Thule Bike Frame Adapter
 - Thule Rear Warning Sign
- See p.70

Garage

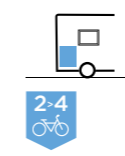

Thule Sport G2 - Garage
Fixed inside your garage compartment. Tiltable when not in use.

LOAD INFO

- 2 bikes extendable to 4
- Weight: 5.6kg
- Max loading weight: 50kg
- Max bike weight: 19kg
- 306574



THULE EXTENSION KIT



Thule Sport G2 4th Rail Kit
To position a 4th bike on the bike carrier.
• 306578

ACCESSORIES

- Thule Brake Straps
 - Thule Bike Frame Adapter
- See p.70

Thule Van Bike Carrier

The range designed for vans

Bikes load capacity:
🚲 2 > 3

Maximum capacity:
35 > 50kg

🇨🇦 The perfect solution
for vans

REAR DOORS



2-3
🚲

Thule Sport G2 - 2 doors

Doors can be opened with bikes on. Either mounted on the lefthand or the righthand rear door.

LOAD INFO

- 2 bikes extendable to 3
- Weight: 7.3kg
- Max loading weight: 50kg
- Max bike weight: 19kg
- 306576

THULE EXTENSION KIT



Thule Sport G2 3rd Rail Kit

To position a 3rd bike on the bike carrier.
• 306577

ACCESSORIES

- Thule Knob with Lock
 - Thule Rear Warning Sign
 - Thule Brake Straps
 - Thule Bike Frame Adapter
- See p.70



2
🚲

Thule Elite G2 - Van

Doors can be opened with bikes on. The platform is adjustable in 3 height positions. Suitable for Ducato, Jumper and Boxer from 2007.

LOAD INFO

- 2 bikes
- Weight: 9.5kg
- Max loading weight: 35kg
- Max bike weight: 19kg
- 306564

ACCESSORIES

- Thule Knob with Lock
 - Thule Rear Warning Sign
 - Thule Brake Straps
 - Thule Bike Frame Adapter
- See p.70



2
🚲

Thule Sport G2 - Van

Doors can be opened with bikes on. Suitable for Ducato, Jumper, Boxer and VW LT until 2007.

LOAD INFO

- 2 bikes
- Weight: 9.5kg
- Max loading weight: 35kg
- Max bike weight: 19kg
- 306575

ACCESSORIES

- Thule Knob with Lock
 - Thule Rear Warning Sign
 - Thule Brake Straps
 - Thule Bike Frame Adapter
- See p.70



See more information on www.thule.com

Thule Caravan Bike Carrier

The range designed for A-frames

A-FRAME



Bikes load capacity:
🚲 2 > 3

Maximum capacity:
40 > 50 > 60kg

+ **Adjustable Tilt-Stop system:** for easy access to the front locker



Adjustable Tilt-Stop. The Thule Caravan Superb and Thule Caravan Smart are both completely tiltable with bikes on providing easy access to the front locker of the caravan. Thanks to the adjustable Tilt-Stop system the maximum angle to tilt the bike carrier can be set as you please.



Easy & safe. The new locking mechanism makes it very easy to lock the tiltable platform onto the base frame by hand, without any loose parts.



See more information on www.thule.com

Thule Caravan Superb

Superb stability

Strong enough to carry 2 E-bikes. The low platform gives a better center of gravity. It's more safe to drive, and much easier to load your bikes.

Equipment

- Thule Bike Holders with integrated locks
- Thule adjustable Tilt-Stop system
- Completely tiltable with bikes on

ACCESSORIES

- Thule Bike Frame Adapter
 - Thule Brake Straps
- See p.70



THULE EXTENSION KIT

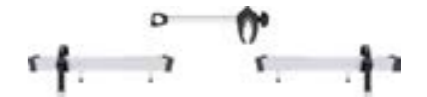

Thule Caravan Superb 3rd Rail Kit
To position a 3rd bike on the bike carrier.
• 307131



LOAD INFO

- 2 bikes extendable to 3
- Weight: 9.7kg
- Max loading weight: 60kg
- Max bike weight: 30kg
- 307130



New

Thule Caravan Superb - Short

Perfect for short A-frames

Strong enough to carry 2 E-bikes.

Equipment

- Thule Bike Holders with integrated locks
- Thule adjustable Tilt-Stop system
- Completely tiltable with bikes on

ACCESSORIES

- Thule Bike Frame Adapter
 - Thule Brake Straps
- See p.70



LOAD INFO

- 2 bikes
- Weight: 9.5kg
- Max loading weight: 60kg
- Max bike weight: 30kg
- 307181



Thule Caravan Smart

Smart features

Safe and easy platform lock.

Equipment

- Thule Bike Holders with optional locks
- Thule adjustable Tilt-Stop system
- Completely tiltable with bikes on

ACCESSORIES

- Thule Knob with Lock
 - Thule Brake Straps
- See p.70



LOAD INFO

- 2 bikes
- Weight: 8.9kg
- Max loading weight: 50kg
- Max bike weight: 30kg
- 307129



Thule Caravan Light

Light and simple

The Thule Caravan Light has been developed to exceed basic needs. The new foam prevents the bike from being damaged during transport. The new wheel and bike holder straps make it easier to fix the bikes.

Partly tiltable, bikes need to be taken off to access storage space.

ACCESSORIES

- Thule Bike Holder 1
 - Thule Brake Straps
- See p.70



LOAD INFO

- 2 bikes
- Weight: 4.7kg
- Max loading weight: 40kg
- Max bike weight: 20kg
- 306598



Thule Lift

Easy up, easy down

+ Easy access platform, manual or motorised

REAR WALL



Thule Lift closed



Adjustable wheel holder



Bike holder

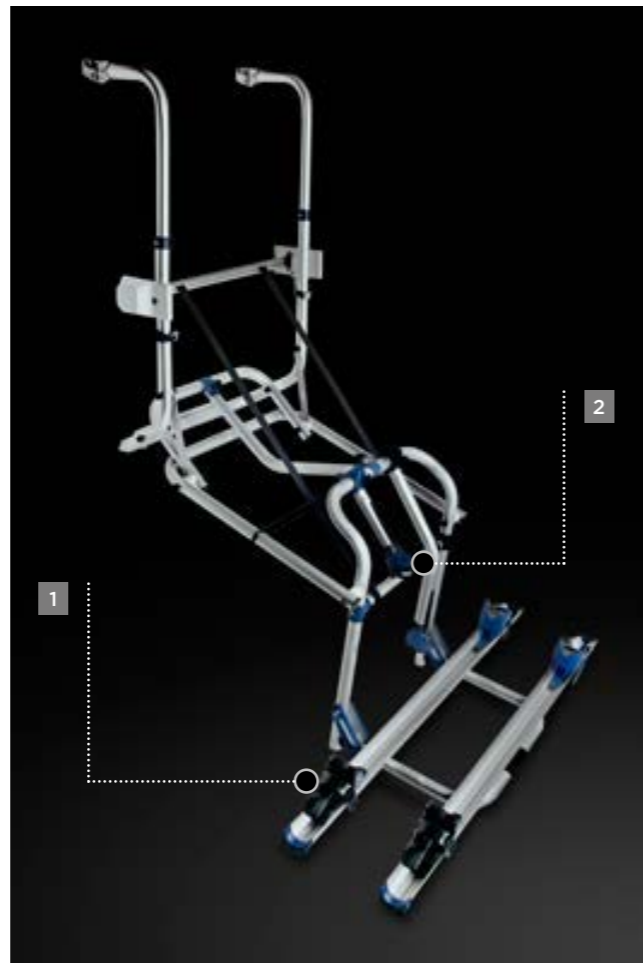

Easy access platform. The Thule Lift can bridge a distance of 70cm in height. The lowest position of the platform makes loading and unloading your bikes simple.



Manual or motorised. The Thule Lift is available either with hand crank or with 12V motor. The motor has been designed to withstand extensive use. The motor enables you to lower your bike carrier platform in 40 seconds.

THULE EXTENSION KIT



Thule Lift 3rd Rail Kit
• 306470

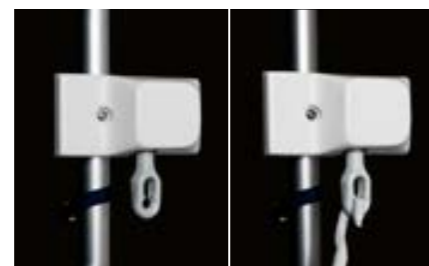

Manual version

- 2 bikes extendable to 3
- Weight: 15.5kg
- Max loading weight: 50kg
- Max bike weight: 19kg
- 307457



Motor 12V version

- 2 bikes extendable to 3
- Weight: 16kg
- Max loading weight: 50kg
- Max bike weight: 19kg
- 307459

See more information on www.thule.com or go to YouTube: typing Thule Lift

New

Thule EasyFold

Space and efficiency

+ Foldable and easy to carry

TOW BAR



Easy to mount in only two steps

The new Thule EasyFold is a user-friendly bike carrier for all types of bikes. In a simple two-step operation, you mount the carrier on the towing hook, unfold it, and it's ready to use. All in a matter of seconds.

Equipment

- Thule AcuTight torque limiter knobs that "click" when optimal torque is reached
- Wheel straps with pump buckles for comfortable fastening of wheels
- Foot pedal tilt for easy trunk access even with bikes on
- Smart handles for transporting the carrier by hand
- Fully foldable for convenient mounting, handling and storage



LOAD INFO

- 2 bikes
- Weight: 17.1kg
- Max loading weight: 60kg
- Max bike weight: 30kg
- 931014

ACCESSORIES
See p.70

Thule EuroClassic G6

Flexible, practical, secure

TOW BAR



For lighter E-bikes

The Thule EuroClassic G6 fits all bikes and wheel sizes. The loading capacity up to 25kg per rail enables E-bike transport. A wide tilt angle allows opening of even very large rear door even with 4 bikes on. A built-in stop prevents the bikes from touching the ground. Available in two versions.

Equipment

- Thule AcuTight torque limiter knobs that "click" when optimal torque is reached
- Pump buckles with long wheel straps for easy fastening of wheels
- Large frame holders for mounting of round and oval frames (22-80mm)
- Carrier lockable on tow bar and all bikes lockable to carrier



LOAD INFO

	2 > 3	3 > 4
• Bikes:	20.7kg	20.7kg
• Weight:	51kg	60kg
• Max load:	25kg	25kg
• Max bike weight:	• 928020	• 929020

ACCESSORIES
See p.70

Thule EuroWay G2

Compact and lightweight

TOW BAR



Design

The perfect choice if you want the best compact and lightweight bike carrier. The award-winning Thule EuroWay G2 has a modern design and weighs only 13kg as a result of using aluminium and other high-tensile lightweight materials. Available in two versions.

Equipment

- Foot pedal tilt for easy trunk access even with bikes on
- Carrier lockable on tow bar and all bikes lockable to carrier
- Folds flat easily for simple storage and fits in most trunks



LOAD INFO

	2	3
• Bikes:	16.4kg	16.4kg
• Weight:	46kg	51kg
• Max load:	24kg	24kg
• Max bike weight:	• 920020	• 922020

ACCESSORIES
See p.70

See more information on www.thule.com

Thule Bike Carrier Accessories

It's all in the details

+ Complete your bike carrier to your needs

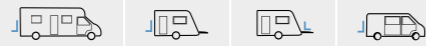

New

Thule Bike Cover

- High quality bike cover to protect your bicycles during transport on a rear mounted bike carrier for recreational vehicles
- Integrated sleeve for warning sign
- Ripstop fabric – water resistant
- Carry bag included for clean storage
- Not allowed for A-frames or tow bar

- Available in 2 sizes
- 307335 - Bike Cover 2/3 bikes
- 307336 - Bike Cover 4 bikes

Thule Rear Warning Sign

- Officially approved aluminium rear reflecting panel for protruding loads
- Mandatory in Spain, Italy, Poland and Hungary when transporting bicycles on the back of a caravan or motorhome
- 50x50cm

New



Rear Warning Sign - Italian type

• 307619



Rear Warning Sign - Spanish type

• 307337



Thule Knob with Lock

- To replace the knob of bike holders without lock
- To lock your bicycles on the bike carrier
- Thule One-Key system: use one key for all locks

- Available in packs of 2 or 4
- 526000 Knob (2pcs) for bike holder with lock + key
- 527000 Knob (4pcs) for bike holder with lock + key



Thule Bike Frame Adapter

- For easiest possible fitting of bike bikes with non-standard frames and ladies' bikes
- Mounts between saddle-post and steering
- Suitable for sensitive carbon frames that need extra protection

• 982003



Thule Brake Straps

- Extra safety for your bikes
- Bind around the hand brakes of the bike during transport
- By pulling the brakes, sideways movement is prevented and the bikes are more secured on the carrier
- Delivered per 6 straps
- Length of the strap: 46.5cm

• 306566



Thule AcuTight Knob 528

- To replace the knob of bike holders without AcuTight
- Adds torque limiter function for clear sign-off of correct mounting of bikes

• 528000



Thule Cable Lock

- A strong, coated cable to secure your bikes
- Length: 180cm

• 538000



Thule EasyFold Carry Bag

- Protecting you and your car from dirt when transporting and storing the Thule EasyFold

• 931100



Thule Bike Carrier Adapters

Thule created a wide range of bike carrier adapters to make the installation of our bike carriers possible on all kinds of vehicles, whatever the situation. We recommend the installation of the bike carrier is done by a professional.

- To fit all kinds of vehicles, for example Hymer, Hobby, ...

FOR MORE INFORMATION CONTACT YOUR THULE RECREATIONAL VEHICLE ADVISOR

Thule E-Bike Rail for Sport G2

- Extra-long rail for E-bike with large wheelbase (1.30m)
- Makes it possible to transport 1 E-bike on a Thule Sport G2 bike carrier
- Easy-fit wheel holders
- Rail can slide left and right

• 306945



Thule Bike Holders with lock

- Adjustable soft-touch bike holders that move from right to left to align with your bike frames
- Patented Key Lock System
- For bike carriers with tube diameter 30mm



• 306463 - Bike Holder 1 with lock length: ± 12cm



• 306464 - Bike Holder 2 with lock length: ± 26cm



• 306466 - Bike holder 4 with lock length: ± 15cm



• 306465 - Bike Holder 3 with lock length: ± 41cm

› Comfort & Security

› Why choose the Thule Comfort and Security Solutions?

Be demanding when it comes to security and safety. Increase your vehicle accessibility and secure your doors, garages or storage areas with these trustworthy products.

› Thule Comfort Solutions

Make your holiday pleasant and comfortable. With a wide range of steps and ladders, access to your vehicle or roof is effortless.



Thule Ladders

- Easy access to the roof of your vehicle
- Extra light and robust



Thule Steps

- Easy access to your vehicle
- Manual or motorised



Thule Vents

- Ideal alternative to air-conditioning
- Integrated mosquito screen

› Thule Security Solutions

Enjoy your activities far from your vehicle with the knowledge your belongings are protected with robust, high quality locks. For safe driving and stability, Thule offers a range of well-designed snow chains and levelers.



Thule Locks

- Wide range of locks for different vehicles
- Maximum security
- Elegant design



Thule Snow Chains

- Excellent grip on ice and snow
- Quick to install and remove
- Different sizes



Thule Levelers

- Stability for your vehicle
- Suitable for wider tyres
- 3 different heights

Thule Ladders

Easy access for everybody

For indoor or outdoor use

Material: anodised or lacquered aluminium

+ Extra light and robust

COMFORT



Ladder Deluxe 6 steps
 • Backside mounting
 • White painted oval arms

• 307496

Ladder 5 steps
 • Indoor use
 • Round anodised tubes

• 307492

Ladder 6 steps
 • Backside mounting
 • Round anodised tubes

• 307487

Ladder 4 steps
 • Backside mounting on van
 • Round anodised tubes

• 307490



Ladder Ducato 10 steps
 • Backside mounting on Ducato model > 2007
 • Round anodised tubes

• Foldable
 • 307494

Ladder 10 steps
 • Backside mounting
 • Round anodised tubes

• Foldable
 • 307488

Ladder Deluxe 11 steps
 • Backside mounting
 • White painted oval arms

• Foldable
 • 307497

Extra light and robust
 Stainless steel fastening components combined with aluminium profiles means the ladder is super light while also being extra solid.

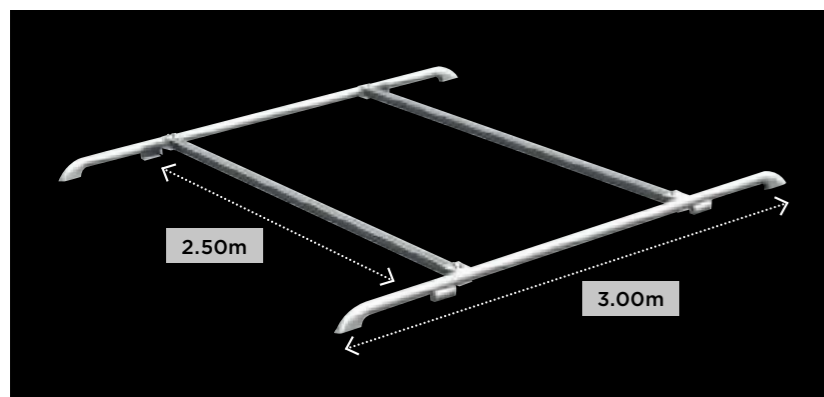

Roof rails with oval profiles

Standard length 3 meters, easy to adjust to the required length. Optional: set of 2 accompanying diagonal rails in aluminium with a standard length of 2.50m.

- Loading capacity: 70kg
- Roof rails aluminium: 307516
- Roof rails white lacquered: 307511
- Cross rails: 307499
- Roof rack for Ducato vans (1.50x1.50m)
 - 307504 (model >2007)
 - 307503 (model <2007)

See more information on www.thule.com

Thule Steps

Easy access to your vehicle

COMFORT



+ Large choice:
3 motorised steps
2 manual steps

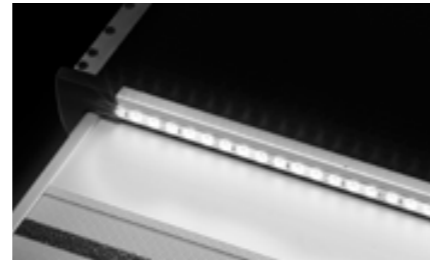

LED: maximum visibility. To be clearly visible under all conditions, each step of the motorised models can be equipped with LEDs.

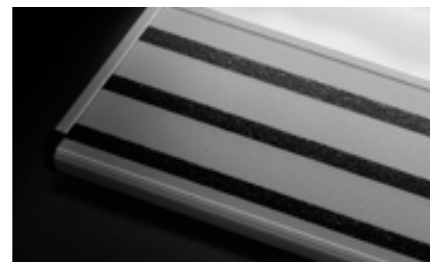

Extra safety. A switch for the connection of a warning lamp inside the vehicle is included as standard, making it impossible to drive away with the step still out.

High quality. Extremely robust, the steps are made of corrugated anodised aluminium. Their quality exceeds European quality standard EN1646.

Motorised version. For even greater convenience, opt for the motorised version. This model is operated by a simple switch, conform to the EMV and CE norms.

The black part inserts easily under the vehicle



The aluminium step automatically unfolds when the switch is pressed

3 motorised steps

2 manual steps



Slide-Out 12V

Double Step 12V

Single Step 12V

Slide-Out Manual

Single Step Manual

• 400 - 550 - 700mm

• 380 - 440 - 500mm

• 460 - 550mm

• 400mm

• 550mm

See more information on www.thule.com

Thule Vents

Practical for fresh and healthy air

COMFORT



+ An ideal alternative to air-conditioning



Mosquito screen. The Thule Vent model includes a removable mosquito screen on the outside to keep dirt and vermin out. It's very easy to clean.



Natural airing: use The Thule Vent as a window. An aerodynamic design means you no longer need a spoiler. The roof light is mounted with special clamps so drilling is not needed, except for the opening itself.

Ventilation: combine the Thule Vent with a motorised ventilator. Provides fresh air and ventilation instantly. A simple press on the button of the control panel adjusts the speed and rotation direction. Plus, it is silent and extremely low on energy consumption.

Security. In addition to 12 ventilation speeds, the Thule Vent has an energy-saving function, a boost function, and a safety mechanism to guard against excess voltage, incorrect connection and blockage.

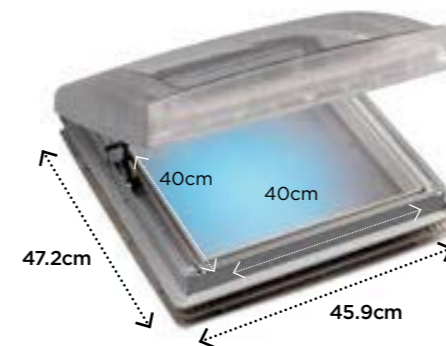

• Outside: 47.2x45.9cm
• Inside: 40x40cm

• Motor 12V
• Max. 20m³/min.

• Weight: from 3 to 4.5kg
• All materials are made of impact and weather-resistant plastics

• Ventilation and extraction
• Connection with thermostat or motion sensor is also possible

FINISHES



White

Translucent

Transparent

Thule Locks

Maximum security for your vehicle

SECURITY



Elegant design

Material:
solid powder-coated aluminium

+ High security, maximum safety



Thule Door Lock

This quality door lock is easy to use: just slide it sideways to lock and secure your doors. Mounted through the wall with a mounting plate, a sealing cover and bolts. Fits left or right opening doors.

PACK

- 1 piece: 308888
- 3 pieces: 308890



Thule Door Frame Lock

This variant of the Thule Door Lock enables installation when there is no space inside the vehicle to fit the mounting plate. Instead of through the wall, it is screwed into the door frame.

PACK

- 1 piece: 308889
- 3 pieces: 308891



New

Thule Inside-Out Lock G2

This lock is mounted through the wall of your vehicle and secures the entrance door from the inside and outside. It's lockable from both sides but for your safety it can always be opened from the inside.

INFO



- Limited space required for installation
- Large overlap with door for high security
- Can be installed horizontally or vertically
- Max. wall thickness: 45mm

PACK

- 1 piece: 307339



Thule Security Handrail

This handrail has a unique double locking design for extra safety: in locked position it folds across the door giving added visible security. Plus, in opened position it offers a sturdy handle to help you get in and out of your vehicle.

PACK

- 1 piece: 308892
- Also available: kit for door frame installation • 308893

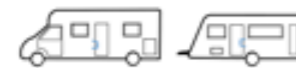

Thule Cab Lock

This lock secures your cabin door from the inside with a key. It offers a soft touch cover and matches the colour of your interior. Designed to fit the Fiat Ducato and Ford Transit. Special variants available for MB Sprinter and Renault Master.

PACK

- Ducato - 2 pieces: 309830
- Sprinter - 2 pieces: 309831



Thule Van Lock

This high security lock helps you to secure rear and sliding side doors. Smart and attractive, it fits all van models and matches the colour of your van's bumper and handles.

PACK

- 1 piece: 309832
- 2 pieces: 309833



See more information on www.thule.com

Thule XS-16

Snow safety you can rely on

+ Large choice:
7 sizes

SECURITY



Easy installation. Thanks to the Thule patented external quick release system, the chains are extremely quick to install and remove.

High reliability. Equipped with the Thule patented self centring and self tensioning system with micro regulation solution, the chains offer excellent grip on ice and snow.

FOR COMPLETE COMPATIBILITY (VEHICLE - TYRE'S SIZE - CHAIN) AND OTHER TECHNICAL INFORMATION PLEASE REFER TO YOUR THULE RECREATIONAL VEHICLE ADVISOR.

INFO

- From 9.35 to 10.69kg
- 7 sizes from 210 to 245
- 16mm link diameter

Online Fit Guide - See more information on www.thule.com

Thule Levelers

The stable way to park

+ Practical:
3 heights

SECURITY



Top stability. Our levelers offer a very large surface area for increased stability, making them ideal for wider tyres, with a maximum load capacity of 5 ton/set.



The striped area offers perfect grip between the tyre and the leveler

Carry bag. The set of two levelers is delivered in a handy carry bag, which makes them easy to store and keep clean.



Elected best levelers: Reisemobil Int. comparison test

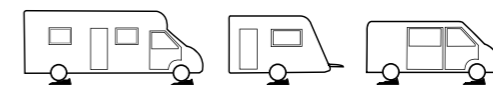

INFO

- 3 heights: 44 - 78 - 112mm
- 560Lx200Wx150Hmm
- Weight: 1.8kg per leveler
- 307617

› The world of Thule

What started out in 1942 as a one-man factory making pike traps has today evolved into a world-known brand. These seventy years have been an exciting journey for Thule, and along the way we've developed many innovative products. And each year the range has grown. In this catalogue we've collected all our recreational vehicle accessories, but that's just a small part of everything that's Thule. Thule is also a part of Thule Group, a collection of international brands that have one common mission: develop smart ways to simplify your active life.

www.thule.com
Get to know our products and find our dealers.



› PART OF THULE GROUP

THULE IN SOCIAL MEDIA

The full experience of Thule is completed through our other media channels. Visit us at Facebook or be inspired at our YouTube channel, which among other things contains a number of product films.

www.facebook.com/thulebringyourlife
www.youtube.com/thulebringyourlife

THULE GROUP

Thule is a part of Thule Group, a collection of international brands that have one common mission: developing smart ways to simplify your active life.

www.thulegroup.com



Thule nv

Kortrijkstraat 343 - BE - 8930 Menen
+32 56 52 88 99 - InfoRV@thule.com
www.thule.com



Your Thule Dealer

Local variations in product range may occur and products may be subject to change without further notice.
With reservation against possible mistakes in the contents of the catalogue.
Concept + graphic design: Hervé Ménard -
Photography: Bram Declercq, Marcel Pabst, David Meignan, Fabienne Nury, Hanne Ninclus - Print: Tanghe Printing
Location cover: Les Lacs de l'Eau d'Heure
307316 - EN

